

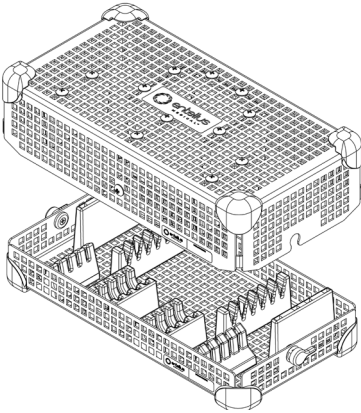

MiniFESS™ Sterilization Tray

3483-001

INSTRUCTIONS FOR USE



The instructions provided within have been validated by the device manufacturer as being capable of reprocessing reusable medical devices.

Individual sterilizers, instrument cleanliness, specific loading of instrument trays, types and geometry of instruments, sterilization containers, filters and wrappings vary at each location.

TABLE OF CONTENTS

SUBJECT	PAGE
Read First	
Indications for Use	1
Device Description	1
Sterilization Methods and Configurations	1
Limitations	1-2
Warnings	2
Universal Precautions	2
Points of Use	2
Cleaning	2
Disinfection	2
Maintenance, Inspection and Testing	2
Sterilization	2-3
Storage	3
Warranty	3

READ THIS SECTION BEFORE PLACING PRODUCT INTO SERVICE

Indications for Use:

The MiniFESS™ Sterilization Tray is used to organize and protect the MiniFESS instruments that are sterilized by a healthcare provider. The MiniFESS Sterilization Tray is intended to allow sterilization of the enclosed medical devices during a pre-vacuum steam sterilization cycle.

The Tray is intended to be used in conjunction with a legally marketed wrap. The Tray is not intended on it's own to maintain sterility.

Device Description:

The MiniFESS Sterilization Tray is used to enclose and hold the MiniFESS instruments in an organized manner during the sterilization process and subsequent storage and transportation. The tray does not have direct patient contact. The tray by itself does not maintain sterility. The tray is composed of aluminum and has a rectangular base with latchable cover. The tray has perforations to allow sterilant penetration. The tray contains silicone instrument holders in the base and/or cover to hold, organize and protect the surgical instruments within the tray during the sterilization process and subsequent storage and transportation.

Sterilization Methods and Configurations

» Autoclave Sterilization Parameter:

- Cycle: Pre-vacuum
- Temperature: 270°F (132°C)
- Exposure Time: 4 minutes
- Minimum Dry Time: 30 minutes

Limitation on Processing

- 1) The end of useful life on the Tray is a minimum of 25 sterilization cycles. Inspect the tray before use for wear and damage caused by use and discontinue use if visible signs of wear are present including corrosion, mechanical failures, cracking, peeling, flaking, broken welds, damaged feet, damaged latches, damaged Hold-Its® / Hold-Downs™, discoloration, etc.
- 2) See **TABLE 2** for sterilization methods and configurations.
- 3) **DO NOT OVERLOAD** the Tray or components.
- 4) **DO NOT OVERLOAD** individual Hold-It slots. Load only one instrument per Hold-It slot.
- 5) Inside of sterilizers, **DO NOT STACK** individually wrapped Trays or components. Separate wrapped Trays or components from each other or any other items on separate shelves of the sterilizer to allow for maximum sterilant flow.
- 6) The use of non absorbent tray liners (ie. silicone fingered organizing mat) can cause condensate to pool. If visible moisture is present, re-sterilize with a longer dry time.

Limitation on Processing (CONT.)

- 7) No lumen claims as the MiniFESS instruments have no lumens.
- 8) The total weight of the system (e.g. tray and instrument load) must not exceed 25 pounds.
- 9) The MiniFESS instruments should be prepared and sterilized according to the instructions for use, see Instructions for Use, (REF 2448-001 & 3103-001).

WARNINGS

Use only neutral (6.0 - 8.5) pH detergents with the sterilization tray to avoid damaging the finish. A detergent with a highly acidic or highly alkaline pH could permanently damage the anodized aluminum finish of the tray and metal components.

Note: Clean and inspect tray according to the instructions provided prior to placing into service and after each subsequent use.

UNIVERSAL PRECAUTIONS

- Personnel should wear all personal protective clothing and equipment as required by their employers / department's operating procedures for the contamination level they will be exposed to.
- Keep dissimilar metals separated during sterilization to prevent corrosion.

POINT OF USE

Remove soil with disposable cloth/paper wipe.

CLEANING

Equipment: Enzymatic detergent, brush and running water. Use neutral (6.0 - 8.5) pH solutions, mildly alkaline and free of sodium carbonate to avoid damaging finish on aluminum tray. **DO NOT** use scouring pads or abrasive cleaners. **DO NOT** store tray in liquid.

Manual Gross Decontamination:

- 1) Remove all visible soil and contaminants using a soft bristle brush. The entire tray should be immersed while cleaning to aid in the removal of contaminants and to reduce splashing of detergent on personnel for a minimum of 2 minutes.
- 2) Rinse thoroughly for a minimum of 1 minute with clean water to remove all detergent. See rinsing instruction on the detergent label.

Ultrasonic clean:

Prepare enzyme wash in an ultrasonic cleaning unit. Place a single tray in the detergent and run for a minimum of ten minutes. Rinse for a minimum of 2 minutes with cold tap water. Visually inspect tray for contaminants. Repeat the cycle if necessary to remove visible contamination.

Automated washer:

The trays will complete the cleaning process in an automatic washer system. The validated cleaning process is reflected in **TABLE 1**.

TABLE 1:

CYCLE	WATER TEMPERATURE	CLEANING PROCESS
Pre-Wash 1 & 2	Cold Tap Water	Re-Circulation Time: 2 Minutes
Enzyme Wash	Hot Tap Water	Soaking Time: 4 Minutes
Wash 1	Heated at 150°F (65.5°C)	Re-Circulation Time: 15 Minutes
Rinse 1 & 2	Hot Tap Water	Re-Circulation Time: 5 Minutes

Note: After completion of an automatic wash cycle, visually inspect the tray for any remaining visible soil. All visible soil must be removed by hand cleaning, brushing, ultrasonic and additional automatic cycles prior to sending to sterilization.

DISINFECTION

The tray is intended to be terminally sterilized.

MAINTENANCE, INSPECTION AND TESTING

The tray may be reused until unacceptable deterioration such as corrosion, cracking, rust, peeling, flaking, discoloration, or mechanical failure occurs. Signs of mechanical failure include:

- Broken or cracked corners or welds
- Missing, torn or cut silicone inserts
- Broken or non-working latches
- Missing or damaged feet

STERILIZATION

See **TABLE 2** for sterilization method and cycle that has been validated for the sterilization of the MiniFESS Sterilization Tray. This method is only valid with sterilization equipment that is properly maintained and calibrated – AAMI TIR 12 p.37. Minimum dry time is required to prevent wet packs.

STERILIZATION (CONT.)

TABLE 2:

STERILIZATION METHOD	CYCLE (times)
Pre-Vacuum Steam	Parameter:
	Temperature 270°F (132°C)
	Expose Time 4 minutes
	Dry Time 30 minutes

The following sterilization method has been validated for the MiniFESS Sterilization Tray:

- The 4 minute autoclave sterilization cycle in legally marketed wrap cleared by the FDA.

Use an FDA cleared wrap to maintain sterility.

Please consult the sterilizer instruction manual to ensure intended loads are compatible with the intended sterilization cycle.

STORAGE

Store terminally sterile trays that are wrapped on storage shelf in a horizontal position. Consult wrap manufacturer for shelf life information.

WARRANTY

LIMITED WARRANTY FOR THE TRAY.

THIS LIMITED WARRANTY AND THE REMEDY PROVIDED HEREIN ARE EXCLUSIVE AND IN LIEU OF ALL OTHER EXPRESS WARRANTIES AND, UNLESS STATED HERE-IN, ANY STATEMENTS OR REPRESENTATIONS MADE BY ANY OTHER PERSON OR FIRM ARE VOID. THE DURATION OF ANY IMPLIED WARRANTIES OF MERCHANTABILITY OR FITNESS FOR A PARTICULAR PURPOSE SHALL BE LIMITED TO THE DURATION OF THE EXPRESS LIMITED WARRANTY. NEITHER SUMMIT MEDICAL, INC. NOR ITS AFFILIATES SHALL BE LIABLE FOR ANY INCIDENTAL, CONSEQUENTIAL OR SPECIAL LOSSES OR DAMAGES, RESULTING FROM THE USE OR INABILITY TO USE THE TRAY, WHETHER RESULTING FROM BREACH OF WARRANTY OR ANY OTHER LEGAL THEORY.

This Limited Warranty gives you specific legal rights, and you may also have other rights which vary from State to State. Some States do not allow limitations on how long an implied warranty lasts, or do not allow the exclusion or limitation of incidental or consequential damages, so the above limitation or exclusions may not apply to you.

What Is Covered. Summit Medical warrants the original purchaser that the Tray enclosed with this Limited Warranty conforms to the manufacturer's specifications and is free from defects in workmanship and material for a period of 12 months from the date of original purchase. If the original purchaser transfers the tray to another party, this Limited Warranty will not be enforceable by the party to whom the product is transferred.

What We Will Do To Correct Problems. Should your Tray prove defective during this period, you must notify Entellus Medical. You must permit the manufacturer to make such investigation, examination and tests as the manufacturer deems appropriate and, if requested to do so, you will return the product to the address set forth below. Entellus Medical's sole obligation under this Limited Warranty is, at its option, to replace the defective product or products, without charge for parts or labor. Postage, insurance or shipping costs incurred in presenting your tray product for warranty service are your responsibility.

What Is Not Covered. This Limited Warranty is contingent upon proper use and maintenance of the product; it does not cover products that have been improperly shipped, or that have been misused, abused, neglected, or improperly maintained, cleaned or stored, or that have been serviced other than by Summit Medical or an authorized distributor or dealer of Summit Medical, or that have been modified without the express approval of Summit Medical. Failure to follow the directions in the owner's manual may constitute improper use or maintenance of the product and causes this Limited Warranty not to apply. This Warranty does not extend to normal wear or to replacement items.

If you have questions or claims related to this warranty, contact Entellus Medical.

 Manufactured by:









Summit Medical LLC
815 Vikings Parkway, Suite 100
St. Paul, MN 55121 | USA

P: 1-888-229-2875 | +1 651-789-3939
F: 1-888-229-1941 | +1 651-789-3979
www.summitmedicalusa.com

Distributed by:

Entellus Medical Inc.
3600 Holly Lane North, Suite 40
Plymouth, MN 55447 | USA
Phone : 1.866.620.7615
www.entellusmedical.com

Symbol Reference Key

						
Consult instructions for use	Quantity	Catalog Number	Lot Number	Date of Manufacture	Non-Sterile	Caution

Not made with natural rubber latex.