

LIFEPAK[®] 1000 DEFIBRILLATOR

OPERATING INSTRUCTIONS

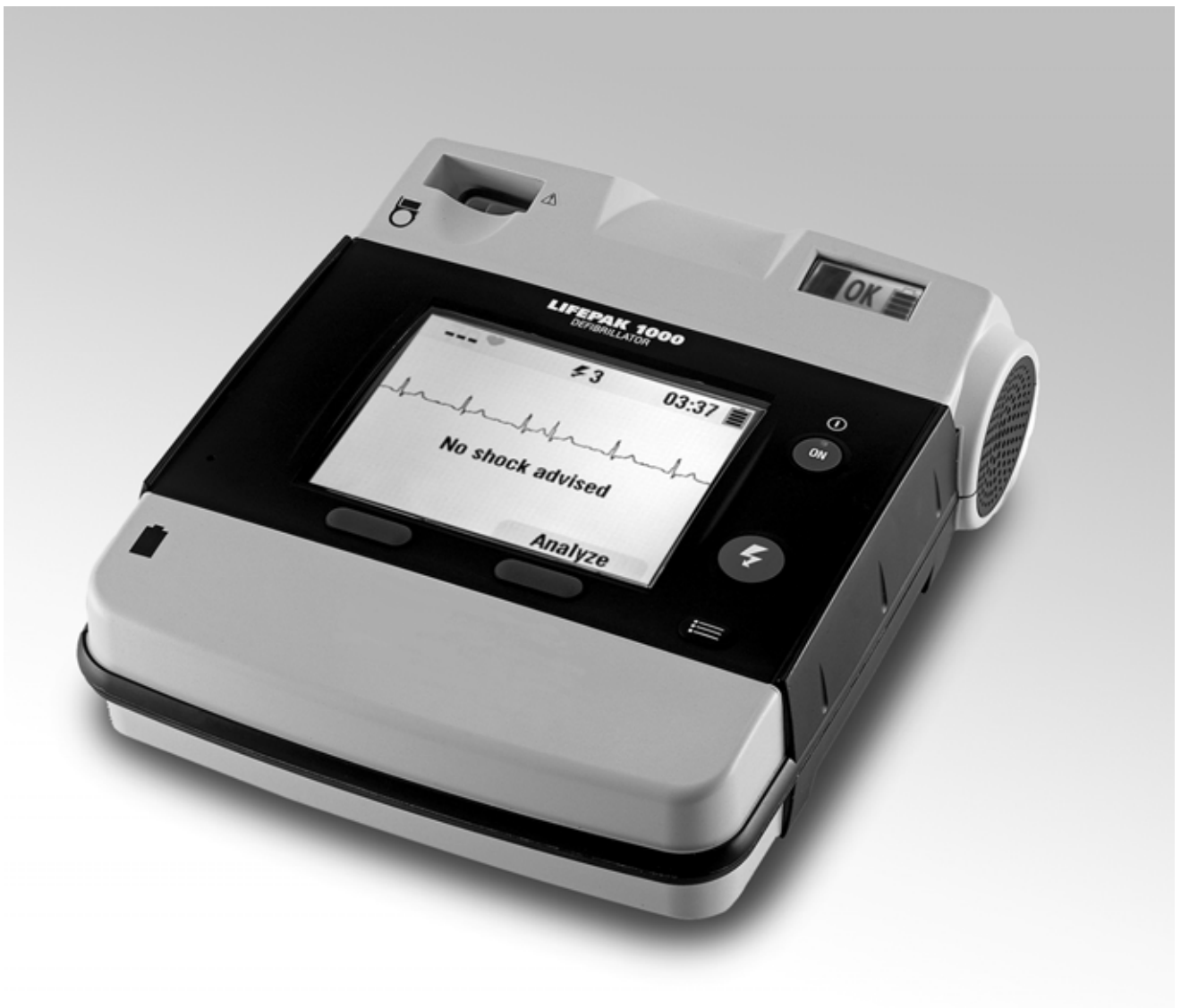



LIFEPAK[®] 1000 DEFIBRILLATOR

OPERATING INSTRUCTIONS

Important

This instrument is to be used by authorized personnel only.

!USA Rx Only

!USA Device Tracking

The U.S. Food and Drug Administration requires defibrillator manufacturers and distributors to track the location of their defibrillators. If the device is located somewhere other than the shipping address or the device has been sold, donated, lost, stolen, exported, destroyed, permanently retired from use, or if the device was not obtained directly from Physio-Control, please do one of the following: register the device at <http://www.physio-control.com>, call the device tracking coordinator at 1.800.426.4448, or use one of the postage-paid address change cards located in the back of this manual to update this vital tracking information

Responsibility for Information

It is the responsibility of our customers to ensure that the appropriate person(s) within their organization have access to this information, including cautions and warnings provided throughout this manual.



LIFEPAK, LIFENET, and QUIK-COMBO are registered trademarks of Physio-Control, Inc. ADAPTIV, CODE-STAT, cprMAX, REDI-PAK, and Shock Advisory System are trademarks of Physio-Control, Inc. Microsoft and Windows are registered trademarks of Microsoft Corporation. Ambu is a registered trademark of the Ambu Corporation. Specifications are subject to change without notice.

©2002–2008 Physio-Control, Inc. All rights reserved.

Publication Date: 10/2008

MIN 3205213-025

TABLE OF CONTENTS

Preface	
About Defibrillation	vi
Indications for Use	vi
Defibrillation.....	vi
ECG Monitoring.....	vi
Operator Considerations	vii
About the LIFEPAK 1000 Defibrillator	vii
Defibrillator Features	vii
Text Conventions	viii

1 Safety	
Terms	1-2
General Warnings and Cautions	1-2
Symbols	1-3

2 Controls and Indicators	
Controls and Indicators	2-2

3 How to Use the LIFEPAK 1000 Defibrillator	
Modes of Operation	3-2
Defibrillation Warnings and Cautions.....	3-2
Defibrillation in AED Mode	3-3
Basic Steps for Using the LIFEPAK 1000 Defibrillator	3-3
Special Situations for Electrode Placement	3-4
Defibrillation in Manual Mode	3-5
Analysis	3-6
Troubleshooting Tips for Defibrillation	3-6

ECG Monitoring (ECG Mode)	3-8
Troubleshooting Tips for ECG Monitoring.....	3-9
<hr/>	
4 Data Management	
Managing Defibrillator Data	4-2
Overview of Data Storage	4-2
Data Stored by the LIFEPAK 1000 Defibrillator	4-2
Overview of Connections for Transmitting Reports	4-3
<hr/>	
5 Caring for the LIFEPAK 1000 Defibrillator	
Maintenance and Testing Schedule	5-2
Self-Test Performance	5-2
Self-Tests.....	5-2
Auto Tests	5-2
Inspection	5-3
Cleaning	5-4
Battery Maintenance	5-4
Electrode Storage	5-5
Service	5-6
Product Recycling Information	5-6
Supplies, Accessories, and Training Tools	5-7
Warranty Information	5-7
<hr/>	
A Specifications	
B Shock Advisory System	
C cprMAX™ Technology	
D Changing Setup Options	
E User's Checklist	
<hr/>	
Index	

PREFACE

This section provides information about defibrillation and an overview of the LIFEPAK® 1000 defibrillator.

About Defibrillation	page vi
Indications for Use	vi
Operator Considerations	vii
About the LIFEPAK 1000 Defibrillator	vii
Text Conventions	viii

ABOUT DEFIBRILLATION

Defibrillation is a recognized means of terminating certain potentially fatal arrhythmias. A direct current defibrillator applies a brief, high-energy pulse of electricity to the heart muscle. The Physio-Control LIFEPAK® 1000 defibrillator is an automated external defibrillator (AED) that delivers this energy through disposable defibrillation electrodes applied to the patient's chest.

Defibrillation is only one aspect of the medical care required to resuscitate a patient with a shockable ECG rhythm. Depending on the situation, other measures may include:

- Cardiopulmonary resuscitation (CPR)
- Supplemental oxygen
- Drug therapy

It is recognized that successful resuscitation is related to the length of time between the onset of a heart rhythm that does not circulate blood (ventricular fibrillation, pulseless ventricular tachycardia) and defibrillation. The American Heart Association has identified the following as critical links in the chain of survival from sudden cardiac arrest (SCA).

- Early access
- Early CPR by first responders or bystanders
- Early defibrillation
- Early advanced life support

The physiological state of the patient may affect the likelihood of successful defibrillation. Thus, failure to resuscitate a patient is not a reliable indicator of defibrillator performance. Often, patients will exhibit a muscular response (such as jumping or twitching) during energy transfer. The absence of such a response is not a reliable indicator of actual energy delivered or defibrillator performance.

INDICATIONS FOR USE

Defibrillation

Defibrillation is a recognized means of terminating certain potentially fatal arrhythmias, such as ventricular fibrillation and symptomatic ventricular tachycardia.

The defibrillator is to be used in AED mode only on patients who are in cardiopulmonary arrest. The patient must be unresponsive, not breathing normally, and showing no signs of circulation.

The defibrillator may be used with standard defibrillation pads only on adults and children who are 8 years old or more or who weigh more than 25 kg (55 lbs). The defibrillator may be used on children who are less than 8 years old or weigh less than 25 kg (55 lbs) with Infant/Child Reduced Energy Defibrillation Electrodes.

ECG Monitoring

ECG monitoring is for use on conscious and unconscious patients of all ages for the purpose of ECG rhythm recognition and heart rate monitoring.

OPERATOR CONSIDERATIONS

The LIFEPAK 1000 defibrillator requires operator interaction to defibrillate the patient.

The defibrillator is intended for use by personnel who are authorized by a physician or medical director and have, at a minimum, the following skills and training.

- CPR training
- Defibrillator training equivalent to that recommended by the American Heart Association
- Training in the use of the LIFEPAK 1000 defibrillator

The LIFEPAK 1000 defibrillator is intended for use in hospital and out-of-hospital environments.

Manual mode is intended for use by personnel trained in ECG recognition who want to use the defibrillator to deliver a shock independent of AED mode. The operator has control over the charging and delivery of shocks.

ECG mode provides a nondiagnostic ECG display and is intended for use by personnel trained in ECG recognition to allow for rhythm and heart rate monitoring using standard ECG electrodes. When in ECG mode, the defibrillator's shock capability is disabled; however, the LIFEPAK 1000 defibrillator continues to analyze the patient's ECG for a potentially shockable rhythm.

ABOUT THE LIFEPAK 1000 DEFIBRILLATOR

The LIFEPAK 1000 defibrillator is a semiautomatic model that can be operated in either of three modes: AED mode, Manual mode, and ECG mode. The defibrillator uses the patented Physio-Control Shock Advisory System™ (SAS) to analyze the patient's electrocardiographic (ECG) rhythm and prompts you when it detects a shockable rhythm and when it does not detect a shockable rhythm. Responder interaction is required to provide therapy (defibrillation) to the patient.

Defibrillator Features

The following paragraphs introduce the LIFEPAK 1000 defibrillator features.

Heart Rhythm Analysis

The patented Physio-Control Shock Advisory System evaluates the patient's heart rhythm.

ECG Display (optional)

This feature allows display of the ECG using the 3-wire (Lead II) cable and when using the defibrillator in AED mode. This feature is also necessary to use the defibrillator in Manual mode.

Defibrillation Waveform

The defibrillation shock, using ADAPTIV™ Biphasic technology, is delivered in the form of a biphasic truncated exponential (BTE) defibrillation waveform. LIFEPAK biphasic defibrillators measure the patient's transthoracic impedance and automatically adjust the defibrillation waveform current, duration, and voltage to meet the needs of the individual patient. Patient impedance is measured whenever defibrillation electrodes are in contact with the patient.

cprMAX™ Technology

The cprMAX technology is designed to allow resuscitation protocols to maximize the amount of CPR administered during treatment using the LIFEPAK 1000 defibrillator.

When used with the factory default settings enabled, the defibrillator allows AED protocols to be consistent with the 2005 American Heart Association Guidelines for Cardiopulmonary Resuscitation and Emergency Cardiovascular Care and European Resuscitation Council Guidelines for Resuscitation.

Data Management

The LIFEPAK 1000 defibrillator digitally records patient data, including ECG rhythm and delivered shocks. Recorded data may be transferred from the defibrillator to a PC using an infrared connection. The PC must have one of our LIFENET® products installed to collect and review the recorded patient data.

Battery Options

A nonrechargeable lithium manganese dioxide (Li/MnO₂) battery provides power to the defibrillator. The battery has indicators that approximate the remaining state of charge. To save battery life if the defibrillator is accidentally turned on or left on, the defibrillator automatically turns off if it is not connected to a patient and no buttons are pressed for 5 minutes.

Daily Self-Test

The defibrillator performs a daily self-test every 24 hours and every time you turn on the defibrillator. This feature tests the most important circuitry in the defibrillator to give the responder a high degree of confidence that it is ready for use.

Readiness Display

The LIFEPAK 1000 defibrillator includes a readiness display. The OK symbol appears in the display if the daily self-test is completed successfully. A battery symbol that approximates the remaining state of charge is also visible. If the self-test detects that service is required, the OK symbol disappears and the service symbol appears.

TEXT CONVENTIONS

Throughout this manual, special text characters are used to indicate labels, screen messages, and voice prompts.

Operating control labels:	CAPITAL LETTERS such as ON/OFF and SHOCK.
Screen messages, and voice prompts:	<i>CAPITAL ITALICIZED LETTERS</i> such as <i>PUSH ANALYZE</i> and <i>CONNECT ELECTRODES</i> .

SAFETY

This section provides important information to help you operate the LIFEPAK 1000 defibrillator. Familiarize yourself with all of these terms, warnings, and symbols.

Terms	page 1-2
General Warnings and Cautions	1-2
Symbols	1-3

TERMS

The following terms are used either in this manual or on the LIFEPAK 1000 defibrillator.

Danger: Immediate hazards that will result in serious personal injury or death.

Warning: Hazards or unsafe practices that could result in serious personal injury or death.

Caution: Hazards or unsafe practices that could result in minor personal injury, product damage, or property damage.

GENERAL WARNINGS AND CAUTIONS

The following section provides general warning and caution statements. Other specific warnings and cautions are provided as needed in other sections of this manual.

WARNINGS!

Shock hazard.

The defibrillator delivers up to 360 joules of electrical energy. Unless properly used as described in these operating instructions, this electrical energy may cause serious injury or death. Do not attempt to operate this device unless thoroughly familiar with these operating instructions, and the function of all controls, indicators, connections, and accessories.

Shock hazard.

Do not disassemble the defibrillator. It contains no responder-serviceable components and dangerous high voltages may be present. Contact authorized service personnel.

Shock or fire hazard.

Do not immerse any portion of this device in water or other fluids. Avoid spilling any fluids on device or accessories. Do not clean with ketones or other flammable agents. Do not autoclave or sterilize this device or accessories unless otherwise specified.

Possible fire or explosion.

Do not use this device in the presence of flammable gases or anesthetics. Use care when operating this device close to oxygen sources (such as bag-valve-mask devices or ventilator tubing). Turn off gas source or move source away from patient during defibrillation.

Possible electrical interference with device performance.

Equipment operating in close proximity may emit strong electromagnetic or radio frequency interference (RFI) which could affect the performance of this device. RFI may result in improper device operation, distorted ECG, or failure to detect a shockable rhythm. Avoid operating the device near cauterizers, diathermy equipment, cellular phones, or other portable and mobile RF communications equipment. Do not rapidly key EMS radios on and off. Refer to "*LIFEPAK 1000 Defibrillator Electromagnetic Compliance Guidance*" for recommended distances of equipment. Contact authorized service personnel if assistance is required.

Possible electrical interference.

Using cables, electrodes, or accessories not specified for use with this device may result in increased emissions or decreased resistance to electromagnetic interference which could affect the performance of this device or of equipment in close proximity. Use only parts and accessories specified in these operating instructions.

Possible electrical interference.

This defibrillator may cause electromagnetic interference (EMI) especially during charge and energy transfers. EMI may affect the performance of equipment operating in close proximity. Verify the effects of defibrillator discharge on other equipment prior to using defibrillator in an emergency situation, if possible.

WARNINGS! (CONTINUED)

Possible device shutdown.

Always have access to a spare, fully-charged, properly maintained battery. Replace the battery when the device displays a low battery warning.

Possible improper device performance.

Using other manufacturers' cables, electrodes, or batteries may cause the device to perform improperly and invalidates the safety agency certification and may invalidate the warranty. Use only the accessories specified in these operating instructions.

Safety risk and possible equipment damage.

Monitors, defibrillators, and their accessories (including electrodes and cables) contain ferromagnetic materials. As with all ferromagnetic equipment, these products must not be used in the presence of the high magnetic field created by a Magnetic Resonance Imaging (MRI) device. The high magnetic field created by an MRI device will attract the equipment with a force sufficient to cause death or serious personal injury to persons between the equipment and the MRI device. This magnetic attraction may also damage the equipment. Skin burns will also occur due to heating of electrically conductive materials, such as patient leads and pulse oximeter sensors. Consult the MRI manufacturer for more information.

CAUTION!

Possible equipment damage.

This device may be damaged by mechanical or physical abuse such as immersion in water or dropping the device. If the device has been abused, remove it from use and contact authorized service personnel.

SYMBOLS

The following symbols may be found in this manual or on various configurations of the LIFEPAK 1000 defibrillator and its accessories.



Defibrillation-protected. Type BF patient connection



Attention. Consult accompanying documents



Warning. High voltage



Type BF patient connection



Menu button



Battery status symbol



Service symbol

OK

Symbol indicating self-test completed successfully



Use By date shown: yyyy-mm-dd or yyyy-mm



This end up



Fragile/breakable.
Handle with care.



Protect from water



Single use only



Mark of conformity to applicable European Directives



Canadian Standards Association certification for Canada and the United States



Cable Connector



For USA audiences only

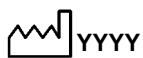

Date of manufacture



Power On/Off



Shock button



Shock symbol



Symbol indicating location of battery compartment

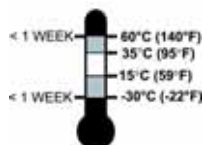

Recommended storage temperature: 15° to 35°C (59° to 95°F). Storage at extreme temperatures of -30° and 60°C (-22° and 140°F) is limited to seven days. If storage at these temperatures exceeds one week, the electrode shelf-life will be reduced.



Recommended shipping temperature: -20° to 50°C (-4° to 122°F).



Relative humidity range 5% to 95%



Do not place near an open flame



Do not crush, puncture, or disassemble battery



Nonrechargeable battery



Refer to instructions for disposal procedure



Do not dispose of this product in the unsorted municipal waste stream. Dispose of this product according to local regulations. See <http://recycling.medtronic.com> for instructions on disposing of this product.



Infant Child Reduced Energy Electrodes are not compatible with QUIK-COMBO defibrillation and therapy cables. To use Infant/Child Electrodes, connect Infant/Child electrodes directly to the AED.

LOT yyww

Lot number (batch code). YY (year) and WW (week) of manufacture.

PN , **MIN**

Manufacturer's item number

CAT

Catalog number

REF

Reorder number

SN

Serial number

Rx Only or **Rx Only**

By prescription only

IP55

Enclosure ingress protection code per IEC 60529

CONTROLS AND INDICATORS

This section provides a description of each of the LIFEPAK 1000 defibrillator primary controls and indications.

[Controls and Indicators](#)

[page 2-2](#)

CONTROLS AND INDICATORS

This section introduces you to the controls and indicators on the LIFEPAK 1000 defibrillator.

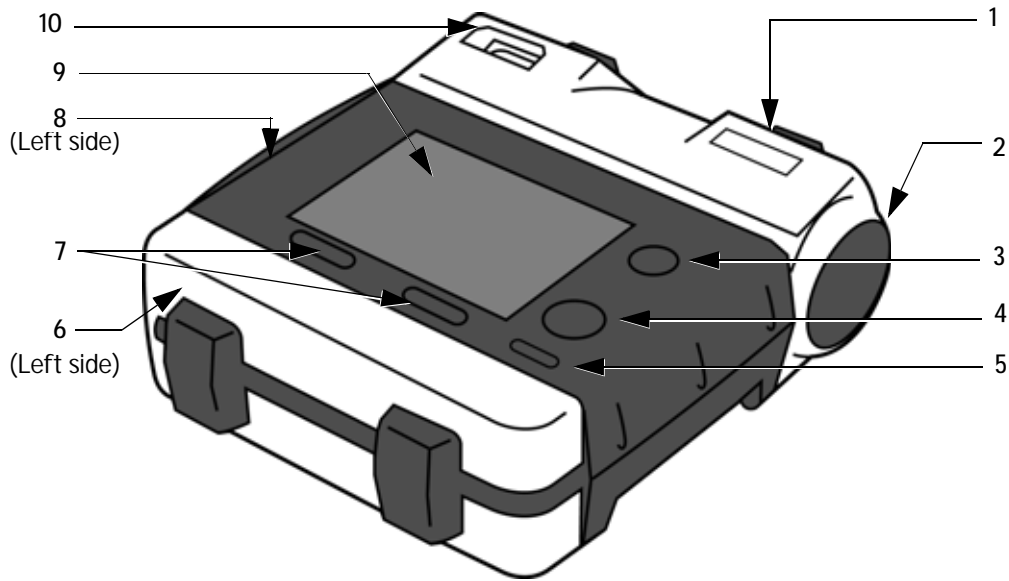

Figure 2-1 Controls and Indicator

Table 2-1 Controls and Indicators











Feature	Description
1	<p>Readiness display</p> <p>The readiness display alerts you to the defibrillator's readiness status.</p> <p>Three symbols (, , ) allow you to determine whether the defibrillator is ready for use or needs attention.</p> <p>The following defines what each symbol represents and when/where each appears.</p>
	<p>The wrench indicator appears on the readiness display when a condition exists that prevents or could prevent normal defibrillator operation.</p>
	<p>The OK symbol indicates that the defibrillator is ready for use.</p> <p>This symbol is visible only when the defibrillator is off.</p>
	<p>The battery symbol appears on the readiness display when the defibrillator is off. When one bar is visible in the symbol, the battery is low. If the symbol is blank, the battery is extremely low and the OK symbol will not appear when the defibrillator is off.</p>
2	<p>Speaker</p> <p>Provides audio voice prompts and tones.</p>
3	<p></p> <p>ON/OFF button</p> <p>Green ON/OFF button turns the power on or off. The button is lit whenever the defibrillator is on.</p>

Table 2-1 Controls and Indicators (Continued)

	Feature	Description
4	 SHOCK button	Pressing the SHOCK button (when flashing) delivers a shock to the patient.
5	 MENU button	Used to select operating modes (Manual or AED) and enter information in Setup mode.
6	Battery compartment	Accommodates a single battery pak.
7	 Softkeys	Two softkeys work in conjunction with the screen, providing a way for you to make selections while using the defibrillator. The softkey functions vary, depending on the task you are performing at the time. Their function is identified by the label above them on the screen.
8	IrDA port	Infrared Data Association. This port provides wireless communications for transferring data from the defibrillator to a PC.
9	Screen	Displays pertinent information for use during all modes of operation. Figure 2-2 defines the information displayed on the screen.
10	Cable receptacle	Allows direct connection to therapy electrodes (black), ECG cable (green), Infant/Child electrodes (pink), and QUIK-COMBO™ therapy electrodes (gray).

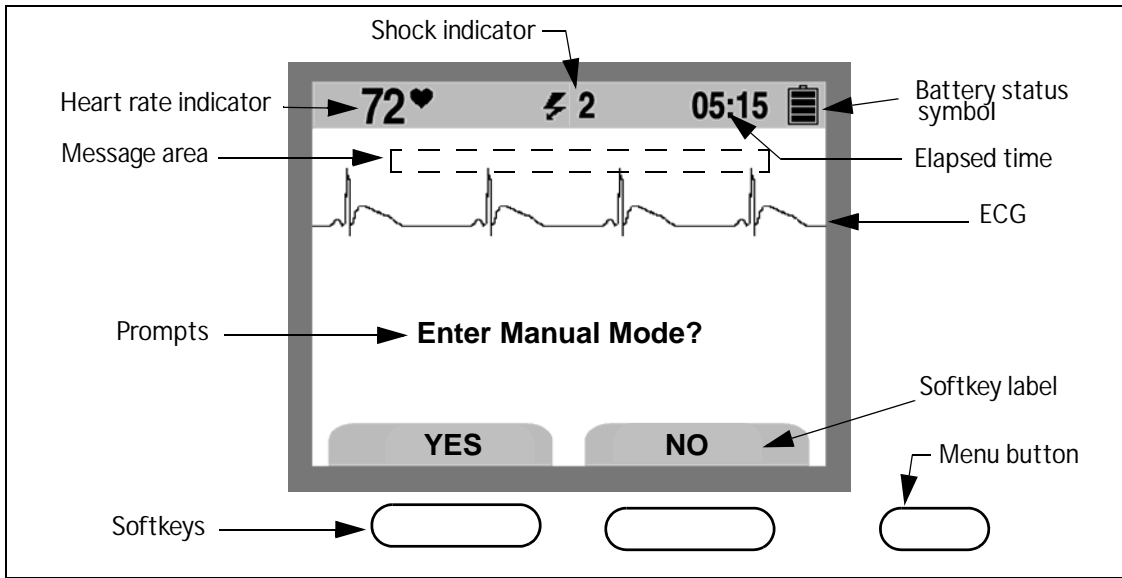

Figure 2-2 Defibrillator Screen

Heart rate indicator. The heart rate indicator displays heart rates between 20 – 300 bpm. Indicator is present in Manual mode or when the 3-wire ECG cable is used.

Battery status symbol. When the defibrillator is turned on, this symbol appears on the screen indicating the relative level of charge. One bar indicates the battery is low. When the battery is very low, the symbol is blank and a *REPLACE BATTERY* message appears on the screen.

ECG. The ECG appearing on the screen is a nondiagnostic ECG, obtained by means of the therapy electrodes or the Lead II ECG cable. The presence of an ECG does not ensure that the patient has a pulse.

Softkey labels. These labels define the function that can be activated by pressing the softkey. *ANALYZE* and *DISARM* are function examples.

HOW TO USE THE LIFEPAK 1000 DEFIBRILLATOR

This section provides an overview of information and instructions for using the LIFEPAK 1000 defibrillator.

Modes of Operation	page 3-2
Defibrillation in AED Mode	3-3
Defibrillation in Manual Mode	3-5
Troubleshooting Tips for Defibrillation	3-6
ECG Monitoring (ECG Mode)	3-8

MODES OF OPERATION

You can use the LIFEPAK 1000 defibrillator for:

- Automated external defibrillation (AED mode)
- Manual defibrillation therapy (Manual mode) (Requires ECG display option)
- ECG monitoring (ECG mode) (Requires ECG display option)

Defibrillation Warnings and Cautions

WARNINGS!

Shock hazard.

The defibrillator delivers up to 360 J of electrical energy. When discharging the defibrillator, do not touch the disposable therapy electrodes.

Shock hazard.

If a person is touching the patient, bed, or any conductive material in contact with the patient during defibrillation, the delivered energy may be partially discharged through that person. Clear everyone away from contact with the patient, bed, and other conductive material before discharging the defibrillator.

Possible skin burns.

During defibrillation, air pockets between the skin and therapy electrodes may cause patient skin burns. Apply therapy electrodes so that entire electrode adheres to skin. Do not reposition the electrodes once applied. If the position must be changed, remove and replace with new electrodes.

Possible skin burns and ineffective energy delivery.

Therapy electrodes that are dried out or damaged may cause electrical arcing and patient skin burns during defibrillation. Do not use therapy electrodes that have been removed from foil package for more than 24 hours. Do not use electrodes beyond expiration date. Check that electrode adhesive is intact and undamaged. Replace therapy electrodes after 50 shocks.

Possible interference with implanted electrical device.

Defibrillation may cause implanted devices to malfunction. Place therapy electrodes away from implanted devices if possible. Check implanted device function after defibrillation, if possible.

Possible misinterpretation of data.

Do not analyze in a moving vehicle. Motion artifact may affect the ECG signal resulting in an inappropriate shock or no shock advised message. Motion detection may delay analysis. Stop vehicle and stand clear of patient during analysis.

Possible misinterpretation of data.

Do not move the AED during analysis. Moving the AED during analysis may affect the ECG signal resulting in an inappropriate shock or no shock advised decision. Do not touch the patient or the AED during analysis.

CAUTION!

Possible equipment damage.

Before using this defibrillator, disconnect all equipment that is not defibrillator-protected from the patient.

DEFIBRILLATION IN AED MODE

The LIFEPAK 1000 defibrillator uses the patented Physio-Control Shock Advisory System to evaluate the patient's heart rhythm. The LIFEPAK 1000 defibrillator has an optional feature that displays the ECG waveform and Heart Rate Indicator in AED mode. The operation in AED mode remains the same whether or not the defibrillator displays the ECG waveform. When ECG DISPLAY is set to ON, the ECG appears with all of the AED messages and prompts. When ECG DISPLAY is set to OFF, the messages and prompts fill the screen.

Basic Steps for Using the LIFEPAK 1000 Defibrillator

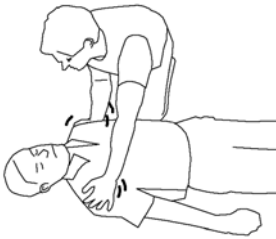

- 1 Establish that the patient is in cardiopulmonary arrest (the patient must be unresponsive, not breathing normally and showing no signs of circulation).



- 2 Press ON/OFF to turn on the defibrillator (the green LED illuminates). Voice prompts will sound, guiding you through the rescue process.

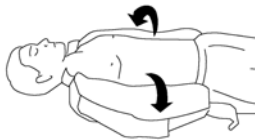

- 3 Prepare the patient for therapy electrode placement.
 - If possible, place the patient on a hard surface away from standing water.
 - Remove clothing from the patient's upper torso.
 - Remove excessive hair from the electrode sites. If shaving is necessary, avoid cutting the skin.
 - Clean the skin and dry it briskly with a towel or gauze.
 - Do not apply alcohol, tincture of benzoin, or antiperspirant to the skin.

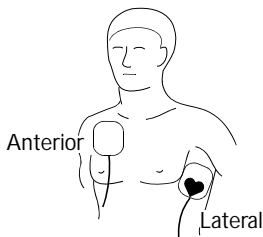

- 4 Apply the therapy electrodes to the patient's chest. Starting from one end, press the electrodes firmly onto the patient's skin, as shown.

WARNING!

Excessive Energy Delivery.
For children less than 8 years of age or 55 lbs (25 kg), use Infant/Child Reduced Energy Defibrillation electrodes. Do not use Pediatric QUIK-COMBO electrodes; these electrodes do not attenuate the energy delivery by this defibrillator.

- 5 Connect the electrodes to the defibrillator (if they are not already connected).
- 6 Follow the screen messages and voice prompts provided by the defibrillator.

The following descriptions of voice prompts and messages are based on the default settings for AED mode. Changing the setup options may result in different AED behavior.

CONNECT ELECTRODES	Voice prompt and message when a patient has not been connected to the defibrillator.
STAND CLEAR, ANALYZING NOW, STAND CLEAR	Voice prompt and message when a patient is connected to the defibrillator. Do not touch or move the patient, or therapy cables, during analysis. ECG analysis requires 6–9 seconds.
PREPARING TO SHOCK	Message displayed if the defibrillator detects a shockable rhythm. The defibrillator charges to the joule setting for that shock number. A rising tone and a charging bar on the screen indicate that the defibrillator is charging.
STAND CLEAR, PUSH SHOCK BUTTON	Voice prompt and message when charging is complete. The ⚡ (shock) button flashes. <i>Clear everyone away from the patient, bed, or any equipment connected to the patient.</i> Press the ⚡ (shock) button to discharge the defibrillator. The energy level for shocks depends on the energy protocol setup option and the analysis decision after shocks. If the ⚡ (shock) button is not pressed within 15 seconds, the defibrillator disarms the shock button, and the <i>DISARMING...</i> message appears on the screen.
ENERGY DELIVERED	Message displayed after each shock.
START CPR	A message and countdown timer (min:sec format) appears for the CPR time.
NO SHOCK ADVISED	Voice prompt and message when the defibrillator detects a nonshockable rhythm. The defibrillator will not charge, and a shock cannot be delivered. When a <i>NO SHOCK ADVISED</i> prompt follows a shock and CPR, the energy level will not increase for the next shock.

Special Situations for Electrode Placement

When placing electrodes on the patient, be aware of special situations:

Obese Patients or Patients with Large Breasts

Apply the electrodes to a flat area on the chest, if possible. If skin folds or breast tissue prevent good adhesion, spread skin folds apart to create a flat surface.

Thin Patients

Follow the contour of the ribs and spaces when pressing the electrodes onto the torso. This limits air space or gaps under the electrodes and promotes good skin contact.

Patients with Implanted Pacemakers

If possible, place defibrillation electrodes away from the internal pacemaker generator. Treat this patient like any other patient requiring emergency care.

Patients with Implanted Defibrillators

Apply the electrodes in the anterior-lateral position. Treat this patient like any other patient requiring emergency care.

Alternate Anterior-Posterior Electrode Position

The electrodes may be placed in an anterior-posterior position as follows:

- 1 Place either the ♥ or + therapy electrode over the left precordium as shown in [Figure 3-1](#). The upper edge of the electrode should be below the nipple. Avoid placement over the nipple, the diaphragm, or the bony prominence of the sternum if possible.
- 2 Place the other electrode behind the heart in the infrascapular area as shown in [Figure 3-1](#). For patient comfort, place the cable connection away from the spine. Do not place the electrode over the bony prominences of the spine or scapula.

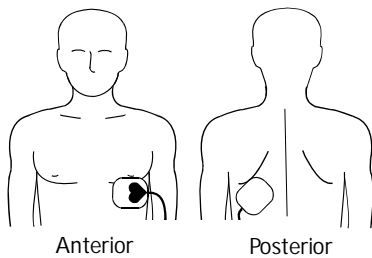

Figure 3-1 Anterior-Posterior Placement

DEFIBRILLATION IN MANUAL MODE

The LIFEPAK 1000 defibrillator provides a Manual mode to override the AED features of the defibrillator. Manual mode provides operator-initiated analysis, charge, shock, and disarm functions. This mode is useful in a tiered response system when a provider trained in manual defibrillation and authorized to place the defibrillator in Manual mode takes over the scene from a BLS-AED trained provider.

To use Manual mode:

- 1 Press the Menu button.
- 2 Select **YES** to enter Manual mode. The ECG trace and Heart Rate Indicator appear on the screen.
- 3 If the displayed ECG rhythm appears shockable, press **CHARGE** to initiate charging of the defibrillator. The screen will indicate that the defibrillator is charging and a charge tone will sound.
- 4 Clear everyone away from the patient, bed, or any equipment connected to the patient.
- 5 When the charge is complete, press the flashing ⚡ (shock) button to deliver energy to the patient.
- 6 After delivering a shock, the energy for each subsequent shock is automatically selected based on the energy level configured in Setup.

Note: To remove an unwanted charge at any time, press **DISARM**.

Analysis

The LIFEPAK 1000 defibrillator can be set up to display an ANALYZE softkey when in Manual mode.

To initiate an analysis:

- 1 Confirm that the patient is unresponsive, not breathing, and without a pulse.
- 2 Press **ANALYZE**.
- 3 If the rhythm analysis results in a No Shock Advised decision, the defibrillator remains in Manual mode without further prompts.
- 4 If the rhythm analysis results in a Shock Advised decision, the defibrillator automatically begins charging accompanied by a charge tone. If you determine that a shock is not warranted, press **DISARM**.
- 5 When the charge is complete, clear everyone away from the patient, bed, or any equipment connected to the patient.
- 6 Press the flashing ⚡ (shock) button to deliver energy to the patient.
- 7 After delivering a shock, the defibrillator remains in Manual mode.

TROUBLESHOOTING TIPS FOR DEFIBRILLATION

This section explains problem conditions that you may encounter while using the defibrillator.

Table 3-1 Troubleshooting Tips for Defibrillation

Observation	Possible Cause	What To Do
Screen blank and ON LED lit.	Screen not functioning properly.	<ul style="list-style-type: none"> • AED and therapy functions may still operate. If needed for therapy, follow voice prompts and continue to use device to treat patient. If unable to use voice prompts for any reason, administer CPR if the patient is not responding, not breathing normally, and showing no signs of circulation. • Contact authorized service personnel.
CONNECT ELECTRODES voice prompt is heard.	Poor electrode-to-skin contact.	<ul style="list-style-type: none"> • Firmly press electrodes on patient's skin. • Clean, shave, and dry the patient's skin prior to placing pads on skin.
	Electrode pads are dry, damaged, or have passed the expiration date.	<ul style="list-style-type: none"> • Replace the electrode pads.
	Electrode pads are not removed from the liner.	<ul style="list-style-type: none"> • Remove the electrode pads from the liner and apply them to the patient's chest
CHECK CONNECTOR AND ELECTRODES voice prompt is heard.	Connection to the defibrillator is inadequate.	<ul style="list-style-type: none"> • Check to be sure that the electrode connector is completely inserted.

Table 3-1 Troubleshooting Tips for Defibrillation (Continued)

Observation	Possible Cause	What To Do
Defibrillator cannot deliver the required shock.	Defibrillator battery power is low.	<ul style="list-style-type: none"> Administer CPR if the patient is not responding, not breathing normally, and showing no signs of circulation. Check battery indicator. Replace battery if needed.
Voice prompts sound faint or distorted.	Defibrillator battery power is low.	<ul style="list-style-type: none"> Administer CPR if the patient is not responding, not breathing normally, and showing no signs of circulation. Check battery indicator. Replace battery if needed.
<i>MOTION DETECTED</i> and <i>STOP MOTION</i> voice prompts are heard.	Patient movement because of location.	<ul style="list-style-type: none"> Move patient to stable location, if possible.
	Patient movement because of breathing.	<ul style="list-style-type: none"> Check patient for normal breathing.
	CPR being performed during analysis.	<ul style="list-style-type: none"> Stop CPR during analysis.
	Vehicle motion.	<ul style="list-style-type: none"> Stop vehicle during analysis, if possible.
Defibrillator does not deliver voice prompts or beeping tones after you turn it on.	Electrical/radio frequency interference.	<ul style="list-style-type: none"> Move communication or other suspected devices away from the defibrillator when possible.
	Speaker not functioning.	<ul style="list-style-type: none"> AED and therapy functions may still operate. If needed for therapy, follow screen prompts and continue to use device to treat patient. If unable to use screen prompts for any reason, administer CPR if the patient is not responding, not breathing normally, and showing no signs of circulation. Contact authorized service personnel.
The readiness display is blank.	Depleted battery.	<ul style="list-style-type: none"> Administer CPR if the patient is not responding, not breathing normally, and showing no signs of circulation. Check battery indicator. Replace battery if needed. Contact authorized service personnel.
	The defibrillator has been turned on.	<ul style="list-style-type: none"> Normal condition when the defibrillator is in use.
	Operating temperature is too low.	<ul style="list-style-type: none"> Operate the defibrillator within the specified temperature range.
	LCD not operating properly.	<ul style="list-style-type: none"> Contact authorized service personnel.

ECG MONITORING (ECG MODE)

WARNING!

Possible misinterpretation of ECG data.

The frequency response of the screen is intended only for basic ECG rhythm identification; it does not provide the resolution required for pacemaker pulse visibility, accurate measurements, such as QRS duration, and ST segment interpretation. For such purposes, use ECG monitors with an appropriate frequency response.

Possible delay in therapy.

Do not attempt to connect a 3-wire ECG cable to a QUIK-COMBO therapy cable or any other AED. The ECG cable is functional only with the LIFEPAK 1000 defibrillator.

The LIFEPAK 1000 defibrillator provides nondiagnostic ECG display of the patient's heart rhythm when the ECG cable is connected and the electrodes are applied.

Note: You do not have to turn the defibrillator off before changing from therapy electrodes to the ECG cable or vice versa.

To monitor a patient's ECG:

- 1 Connect the ECG cable.

Note: The ECG cable uses the same receptacle used by the therapy electrodes.

- 2 Apply ECG electrodes to the patient's chest as shown in [Figure 3-2](#)

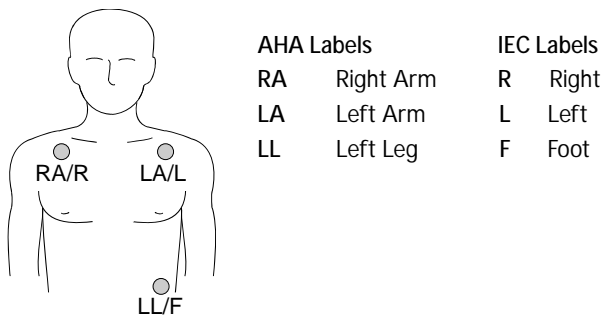

Figure 3-2 Connecting the ECG Electrodes for ECG monitoring

After the ECG electrodes are connected, the defibrillator displays the patient's heart rhythm and heart rate in a lead II configuration. Lead II is the only lead available with this cable.

While in ECG mode, the defibrillator's shock capability is disabled; however, the defibrillator continues to evaluate the patient's ECG for a potentially shockable rhythm. Remember that the presence of an ECG rhythm does not ensure that the patient has a pulse.

If a shockable rhythm is detected, the defibrillator prompts **CONNECT THERAPY ELECTRODES**.

- 1 Confirm the patient's condition: Not responsive? Not breathing? No signs of circulation?
- 2 Remove the ECG cable and connect the therapy electrodes to the defibrillator.
- 3 Apply the therapy electrodes to the patient's chest, keeping them at least 2.5 cm (one inch) away from the ECG electrodes. If necessary, remove the ECG electrodes.
- 4 Follow the defibrillator's voice and screen prompts.

Troubleshooting Tips for ECG Monitoring

If problems occur while monitoring the ECG, check this list of observations for troubleshooting assistance.

Table 3-2 Troubleshooting Tips for ECG Monitoring

Observation	Possible Cause	What to Do
Screen blank and ON LED lit.	Screen not functioning properly.	<ul style="list-style-type: none"> • Contact authorized service personnel. • AED and therapy functions may still operate. If needed for therapy, continue to use device to treat patient.
<i>CONNECT ECG LEADS</i> message appears	One or more ECG electrodes are disconnected.	<ul style="list-style-type: none"> • Confirm ECG electrode connections.
	Poor electrode-to-skin contact.	<ul style="list-style-type: none"> • Reposition cable and/or lead wires to prevent electrodes from pulling away from patient. • Clean, shave, and dry the patient's skin as recommended on page 3-3. • Replace electrodes. • Change cable.
	Broken ECG cable lead wire.	<ul style="list-style-type: none"> • Check ECG cable continuity. If lead wire is broken, replace ECG cable.
Poor ECG signal quality.	Poor electrode-to-skin contact.	<ul style="list-style-type: none"> • Reposition cable and/or lead wires to prevent electrodes from pulling away from patient. Secure cable clasp to patient's clothing. • Clean, shave, and dry the patient's skin as recommended on page 3-3. • Replace electrode(s).
	Outdated, corroded, or dried-out electrodes.	<ul style="list-style-type: none"> • Check date codes on electrode packages. • Use only silver/silver chloride electrodes with Use By dates that have not passed. • Leave electrodes in sealed packet until time of use.
	Loose connection.	<ul style="list-style-type: none"> • Check/reconnect cable connections.
	Damaged cable or connector/lead wire.	<ul style="list-style-type: none"> • Inspect ECG and therapy cables. • Replace if damaged. • Check cable with simulator and replace if malfunction observed.
	Noise because of radio frequency interference (RFI).	<ul style="list-style-type: none"> • Check for equipment causing RFI (such as a radio transmitter) and relocate or turn off equipment power.
Baseline wander (low frequency/high amplitude artifact).	<p>Inadequate skin preparation.</p> <p>Poor electrode-to-skin contact.</p>	<ul style="list-style-type: none"> • Clean, shave, and dry the patient's skin as recommended on page 3-3. • Replace electrodes.

Table 3-2 Troubleshooting Tips for ECG Monitoring (Continued)

Observation	Possible Cause	What to Do
Fine baseline artifact (high frequency/low amplitude).	Inadequate skin preparation. Isometric muscle tension in arms or legs.	<ul style="list-style-type: none">• Clean, shave, and dry the patient's skin as recommended on page 3-3.• Replace electrodes.• Confirm that limbs are resting on a supportive surface.• Check electrodes for proper adhesion.

DATA MANAGEMENT

This section introduces data management for the LIFEPAK 1000 defibrillator.

[Managing Defibrillator Data](#)

[page 4-2](#)

MANAGING DEFIBRILLATOR DATA

The LIFEPAK 1000 defibrillator provides an infrared method to transfer defibrillator data.

Overview of Data Storage

Every time you use the defibrillator, it digitally saves patient data that can be transferred to a PC. You can provide patient data to aid in case review for quality control, training, and research purposes. You should become familiar with local requirements for reporting a use of the LIFEPAK 1000 defibrillator and for providing use data. For assistance in retrieving data from the defibrillator, contact your local Physio-Control sales representative or authorized service personnel.

Data Stored by the LIFEPAK 1000 Defibrillator

Whenever you turn on the defibrillator and connect it to a patient, it automatically stores data about the patient. When this data is transferred to a data management system for review (for example, CODE-STAT™ software), three patient reports are available: Event Log, Continuous ECG, and CODE SUMMARY. [Table 4-1](#) describes these reports.

Table 4-1 Patient Reports

Report Type	Description
Event Log	A chronological log of all events. An event is a condition noted by the defibrillator. Events are listed on page 4-3 .
Continuous ECG	Forty minutes of the patient's ECG rhythm beginning when the patient is connected to the defibrillator and ending when the defibrillator is turned off.
CODE SUMMARY	Combines the Event Log and a sampling of continuous ECG rhythms associated with certain events, such as defibrillation.

The LIFEPAK 1000 defibrillator can store up to two patient records: one for the current patient and one for the previous patient. When you use the defibrillator, it is important to transfer the patient data as soon as possible after use. The Complete Record for the current patient includes the Continuous ECG and Event Log. If you treat a second patient, the first patient's Continuous ECG is reformatted into a CODE SUMMARY report. If you treat a third patient, all of the first patient's data is deleted and the second patient's Continuous ECG is reformatted into a CODE SUMMARY Report.

Table 4-2 Patient Records

	Complete Record	Summary	Continuous ECG
Current Patient	X	X	X
Previous Patient	Ø	X	Ø

If you turn the defibrillator on and off without attaching electrodes to a patient, the defibrillator does not create a new patient record and the patient records in the defibrillator are not altered.

The LIFEPAK 1000 defibrillator does not delete patient data after you transfer the data to a PC. The defibrillator deletes previous patient data only when it is connected to a new patient or a simulator.

Test and Service Data

The LIFEPAK 1000 defibrillator stores a test log consisting of the most recent auto-tests, power cycles, and battery replacements. The test log lists the test results and any errors detected. The test log data is available only to authorized service personnel or to responders who are using the appropriate LIFENET system product.

Event and Test Log

Table 4-3 and Table 4-4 list the types of events that may be annotated on event and test log reports.

Table 4-3 Events

Events	Events	Events
Power On	Shock X Abnormal	Motion
Connect Electrodes	No Shock Advised	Analysis Stopped*
Patient Connected	CPR Prompt	Low Battery
AED Mode	Stop CPR Prompt	ECG Mode
Initial Rhythm*	Check Patient*	Out of Event Memory
Analysis X*	Charge Removed	Out of Waveform Memory
Shock Advised	Manual Mode	Power Off
Charge Complete	Replace Battery	Recovery Time*
SHOCK X-XXXJ*	Charge Button Pressed	

* These events include ECG samples in the Summary Report.

Table 4-4 Test Log Report

Test Log
Self Test Power On
Self Test Pass/Fail
User Power On/Off
Battery Changed

Overview of Connections for Transmitting Reports

Patient, test, and service data can be transmitted from the LIFEPAK 1000 defibrillator to a PC-compatible computer equipped with CODE-STAT software, version 6.0 or later, a Physio-Control LIFENET system product. LIFENET system products are compatible with Microsoft® Windows 2000 Professional and Windows XP.

The LIFEPAK 1000 defibrillator (see [Figure 2-1](#)) supports wireless, infrared communications for transmitting data from the defibrillator to your computer. To receive the transmission, your computer must have an operational IrDA port.

If your computer does not have an IrDA port, you can install an IrDA adapter to provide the needed interface. Physio-Control recommends installing an IrDA adapter on all computers to ensure successful communication connections and data transmissions.

IrDA adapters are available for serial or USB computer ports. Follow the installation and usage instructions provided with the adapter, ensuring that the adapter mount (receiving end) is positioned on a stable surface. [Figure 4-1](#) provides guidelines to follow for positioning the defibrillator and the IrDA adapter before initiating a transmission.

Note: The shaded cone in [Figure 4-1](#) represents the approximate parameters for positioning the defibrillator's IrDA port opposite the IrDA adapter. As the distance between the two increases, so does the possible range for aligning them.

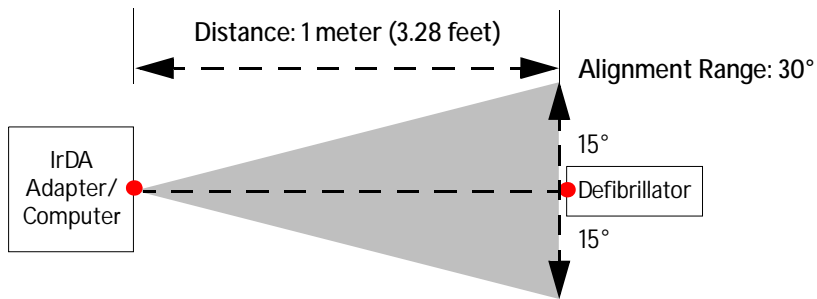

Figure 4-1 IrDA Connections

You initiate and control transmission of device data at your computer using a LIFENET system product. This includes initiating data download, selecting reports to be transmitted, and monitoring transmission progress. More information about configuring your LIFENET system product and instructions for transmitting device data are provided in the users guide and reference cards that accompany the LIFENET system product.

CARING FOR THE LIFEPAK 1000 DEFIBRILLATOR

This section explains how to help keep your [LIFEPAK 1000 defibrillator](#) in good working condition. Cared for properly, the [defibrillator](#) is built to give you many years of service.

Maintenance and Testing Schedule	page 5-2
Self-Test Performance	5-2
Inspection	5-3
Cleaning	5-4
Battery Maintenance	5-4
Electrode Storage	5-5
Service	5-6
Product Recycling Information	5-6
Supplies, Accessories, and Training Tools	5-7
Warranty Information	5-7

MAINTENANCE AND TESTING SCHEDULE

Use the following schedule in conjunction with the internal quality assurance program of the hospital, clinic, or emergency medical service where the defibrillator is used.

On a regular basis, you should do the following:

- Check the readiness display to determine the level of battery charge and that the OK symbol is visible.
- Check the Use By date on the therapy electrode packet.
- Check other emergency supplies that may be stored with the defibrillator.

If the OK symbol is not visible, the level of battery charge is low, or the electrode Use By date has passed, the defibrillator needs attention. Replace the battery and the electrode packet, or call your authorized service personnel.

When establishing your local inspection schedule, consider how often the defibrillator will be used and how familiar the operators are with using a defibrillator. For example, if the defibrillator is used rarely, weekly inspections are appropriate. An inspection checklist is provided in [Appendix E](#).

Table 5-1 Recommended Maintenance Schedule

Operation	After Use	As Required	Weekly
Complete Operator's Checklist (see Appendix E).		X	
Inspect defibrillator.	X	X	
Clean defibrillator.	X	X	
Check that all necessary supplies and accessories, such as electrodes, are present.	X	X	

SELF-TEST PERFORMANCE

Whenever the LIFEPAK 1000 defibrillator is turned on after it has been off for at least 60 seconds, it takes approximately 5 seconds to complete a self-test and to indicate a low or replace battery condition.

Self-Tests

Each time you turn it on, the defibrillator performs internal self-tests to check that internal electrical components and circuits work properly. The defibrillator stores the results of all user power on self-tests in a test log. When the defibrillator is on and a problem requires immediate service, such as a malfunctioning charging circuit, the defibrillator prompts **CALL SERVICE**. Attempt to use the defibrillator if needed for an emergency; otherwise, remove the defibrillator from active use and contact authorized service personnel to correct the problem as soon as possible. The service symbol will remain visible until the problem is corrected.

Auto Tests

The defibrillator performs automatic self-tests daily and monthly at 0300 (3:00 a.m.) if not in use. During the automatic self-test, the defibrillator turns itself on (ON/OFF LED illuminates) briefly and completes the following tasks:

- Performs a self-test
- Stores the self-test results in the Test Log
- Turns itself off

If the defibrillator detects a problem during an auto test that requires service, it displays the service symbol. If the service symbol is visible, you should attempt to use the defibrillator, if needed, for a cardiac emergency. However, you should contact authorized service personnel to correct the problem as soon as possible. The service symbol will remain visible until the problem is corrected.

The automatic self-test is not performed if the defibrillator is already turned on at 0300 or if the battery is not installed. If the defibrillator is turned on while a self-test is in progress, the test is halted; the defibrillator will turn on normally.

INSPECTION

Routinely inspect all devices, accessories, and cables by following the instructions in Table 5-2.

Table 5-2 LIFEPAK 1000 Defibrillator Inspection

Instruction	Inspect For	Recommended Corrective Action
Examine the defibrillator case, connector, battery well, battery pins, and accessories.	Foreign substances.	Clean the device as described in Table 5-3 .
	Damage or cracks.	Contact authorized service personnel to troubleshoot.
	Battery pins bent or discolored.	Contact authorized service personnel.
	Expired batteries or defibrillation electrodes.	Replace.
Observe readiness display	OK symbol	None needed.
	Low or replace battery indication displayed	Replace battery immediately.
	Service symbol displayed	Contact authorized service personnel.
Examine accessory cables.	Foreign substances.	Clean the cables as described in Table 5-3 .
	Inspect for cracks, damage, extreme wear, broken or bent connectors and pins.	Replace damaged or broken parts.
	Confirm that connectors engage securely.	Replace damaged or broken parts.

CLEANING

Clean the LIFEPAK 1000 defibrillator accessories as described in [Table 5-3](#). Use only the cleaning agents listed in the table.

CAUTION!

Possible equipment damage.

Do not clean any part of the defibrillator or accessories with bleach, bleach dilution, or phenolic compounds. Do not use abrasive or flammable cleaning agents. Do not steam, autoclave, or gas-sterilize the defibrillator or accessories.

Table 5-3 Recommended Cleaning Methods

Items	Cleaning Practice	Recommended Cleaning Agent
Defibrillator case, display, crevices, and accessories	Clean with damp sponge or cloth.	<ul style="list-style-type: none"> • Quaternary ammonium compounds • Rubbing (isopropyl) alcohol • Peroxide (peracetic acid) solutions

BATTERY MAINTENANCE

The LIFEPAK 1000 defibrillator is powered by the LIFEPAK 1000 nonrechargeable lithium manganese dioxide battery pak.

Follow the guidelines described in this section to help maximize battery life and performance. Use only Physio-Control battery paks designed for use with the LIFEPAK 1000 defibrillator. Do not use any other batteries.

WARNINGS!

Safety risk and possible equipment damage.

- Damaged batteries may leak and cause personal injury or equipment damage. Handle damaged or leaking batteries with extreme care.
- Do not carry a battery pak where metal objects (such as car keys or paper clips) could short-circuit the battery terminals. The resulting excessive current flow can cause extremely high temperatures and may result in damage to the battery pak or cause fire or burns.
- Keep batteries away from children.

Possible defibrillator shutdown.

When the LIFEPAK 1000 defibrillator displays the REPLACE BATTERY message, replace the battery immediately.

Possible loss of power during patient care.

Using an improperly maintained battery to power the defibrillator may cause power failure without warning. Maintain batteries as described in these operating instructions.

Note: When a battery pak is removed from the defibrillator, battery and service symbols appear on the readiness display. After replacing the battery pak, the device resets the readiness display.

The nonrechargeable battery pak never requires recharging. The approximate level of charge in the battery appears on the readiness display when the defibrillator is off or on the screen when the defibrillator is in use.

When optimally maintained, a new nonrechargeable battery pak can provide approximately 17 hours of “on time” or 440 discharges at 200 joules. Just turning the defibrillator on (“on time”) uses up battery

capacity. Each year, battery capacity decreases while the battery is in the defibrillator because of the battery's normal self-discharge rate and the energy used by the defibrillator auto tests. If installed in the defibrillator and the defibrillator is not used, the battery pak has a standby life of five years.

A new nonrechargeable battery pak has a shelf life of five years if stored at the proper temperature. The battery pak (stored outside the defibrillator) self-discharges over time; therefore, when the battery is eventually placed in the defibrillator, its useful life will be reduced depending on how long it "sat on the shelf."

To properly maintain nonrechargeable battery paks:

- Do not attempt to recharge.
- Do not expose to temperatures greater than those specified in Appendix A.
- Do not allow electrical connection between the battery contacts.

WARNING!

Possible explosion, fire, or noxious gas.

Attempting to recharge a nonrechargeable battery pak can cause an explosion or fire or release noxious gas. Dispose of expired or depleted nonrechargeable battery paks as described in these operating instructions.

CAUTION!

Possible battery damage.

Electrical connection between battery contacts can blow an internal fuse and permanently disable the battery.

ELECTRODE STORAGE

For information about defibrillation electrode storage, refer to the electrode operating instructions.

SERVICE

WARNING!

Shock hazard.

Do not disassemble the defibrillator. It contains no responder-serviceable components and dangerous high voltages may be present. Contact authorized service personnel.

If the LIFEPAK 1000 defibrillator requires service as indicated by testing, troubleshooting, or the service symbol, contact authorized service personnel. In the USA, call 1.800.442.1142. Outside the USA, contact your local Physio-Control representative. When you call Physio-Control to request service, provide the following information:

- Model number and part number
- Serial number
- Observation of the problem that led to the call

If the defibrillator must be shipped to a service center or to the factory, pack it in the original shipping container. If this is not possible, ship the defibrillator in protective packing to prevent shipping damage.

PRODUCT RECYCLING INFORMATION

All materials should be recycled according to national and local regulations. Contact your local Physio-Control representative for assistance or refer to <http://recycling.medtronic.com> for instructions on disposing of this product.

Preparing for Disposal of Nonrechargeable Batteries

Nonrechargeable batteries should be fully discharged before disposal.

Before disposing of nonrechargeable battery paks, cover the battery terminals with the plastic discharger cap provided with the new battery. Refer to the battery discharge instructions included with your new battery.

Disposing of Nonrechargeable Batteries

Follow your national, regional, and local regulations for disposal. Contact a local Physio-Control representative for more information.

In the USA, Environmental Protection Agency and Department of Transportation regulations allow disposal of nonrechargeable batteries with ordinary household waste **provided that they are fully discharged**. Be sure to comply with any other local or regional regulations before disposal. For more information or assistance, contact your local Physio-Control representative or call 1.800.442.1142.

Recycling the Defibrillator

Recycle the defibrillator at the end of its useful life. It should be clean and contaminant-free prior to being recycled.

Recycling Disposable Electrodes

After disposable electrodes are used, follow your local clinical procedures for recycling.

Recycling Packaging

Packaging should be recycled according to national and local regulations.

SUPPLIES, ACCESSORIES, AND TRAINING TOOLS

Table 5-4 lists supplies, accessories, and training tools for the [LIFEPAK 1000 defibrillator](#). To order in the USA, call 1.800.442.1142. Outside the USA, contact your local Physio-Control representative.

Table 5-4 Supplies, Accessories, and Training Tools

Item Description	Catalog Number
QUIK-COMBO™ Electrodes with REDI-PAK™ preconnect system	CAT. 11996-000017
Infant/Child Reduced Energy Defibrillation Electrodes (not compatible with QUIK-COMBO defibrillation cable)	CAT. 11101-000016
Infant/Child Electrodes Starter Kit (English, Dutch, French, German, Spanish, Italian, Danish, Norwegian, Finnish, Swedish)	CAT. 11101-000017
Infant/Child Electrodes Starter Kit (English, Hungarian, Polish, Brazilian Portuguese, Iberian Portuguese, Spanish, Korean, Japanese, Mandarin Chinese)	CAT. 11101-000018
LIFEPAK 1000 nonrechargeable lithium manganese dioxide battery pak	CAT. 21300-006054
Carrying case	CAT. 11260-000025
3-Wire Monitoring Cable	CAT. 11111-000012
3-Wire Monitoring Cable (IEC)	CAT. 11111-000013
Quick Reference Card	CAT. 26500-002156
IrDA Adapter (attachment for a PC)	CAT. 21300-005026 CAT. 21300-005027
CODE-STAT Data Review Software	CAT. 94404-000003
LIFENET DT Express Information Management System	CAT. 21340-000095

WARRANTY INFORMATION

Refer to the product warranty statement included with your [LIFEPAK 1000 defibrillator](#). For duplicate copies, contact your local Physio-Control representative.

APPENDIX A SPECIFICATIONS

SPECIFICATIONS

All specifications are at 20°C (68°F) unless otherwise stated.

Defibrillator

Waveform Biphasic Truncated Exponential with voltage and duration compensation for patient impedance.

With Adult Pads:

Patient Impedance Range: 10 – 300 ohms

The following specifications apply from 25 to 175 ohms.

Energy Accuracy:

10% of the energy setting into 50 ohms

15% of the rated energy output into 25 – 175 ohms

Rated energy output is the nominal delivered energy based on the energy setting and patient impedance, as defined in the following chart.

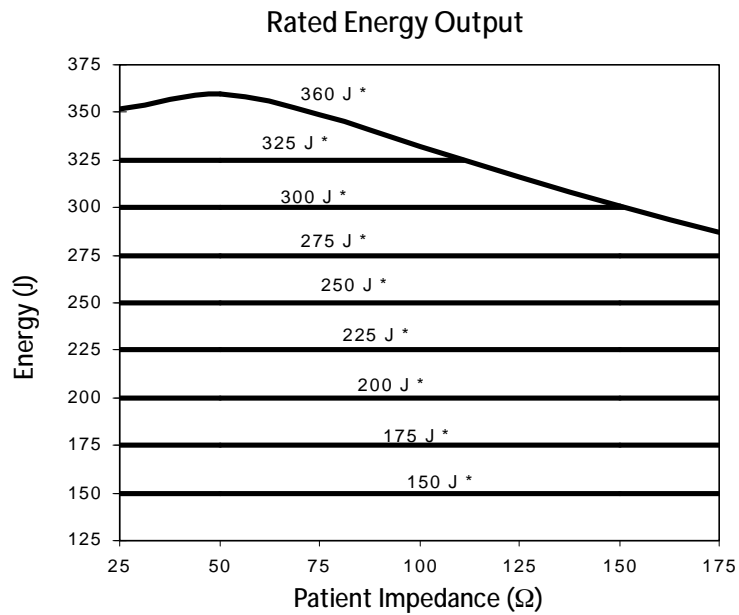

* Energy setting selected

Waveshape and Measured Parameters:

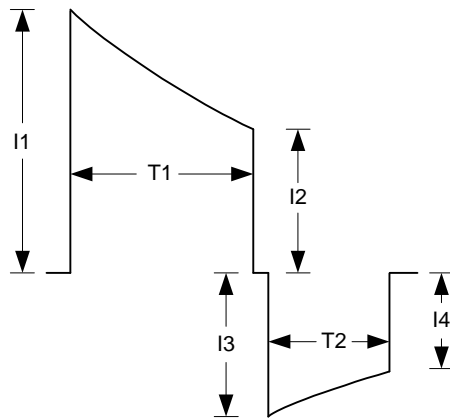

Patient Impedance (Ω)	I1 (A)	I2 (A)	I3 (A)	I4 (A)	T1 (ms)	T2 (ms)
25	50.3	20.1	19.7	10.7	5.9	3.9
50	28.2	14.6	14.5	9.3	7.5	5.0
75	19.8	11.7	11.7	8.2	8.7	5.8
100	15.5	10.0	9.9	7.3	9.7	6.5
125	12.9	8.7	8.7	6.6	10.4	7.0
150	11.1	7.8	7.7	6.2	11.1	7.4
175	9.8	7.1	7.1	5.7	11.7	7.8

Note: Table values are nominal for a 200-joule shock.

Waveform
(continued)

With Infant/Child pads:

The following specifications apply from 25 to 175 ohms.

Energy Accuracy (into 50 ohms):

Selected energy \div 4 +/- 15%; 86 joules +/- 15% maximum

Rated energy output is the nominal delivered energy based on the energy setting and patient impedance, as defined in the following chart.

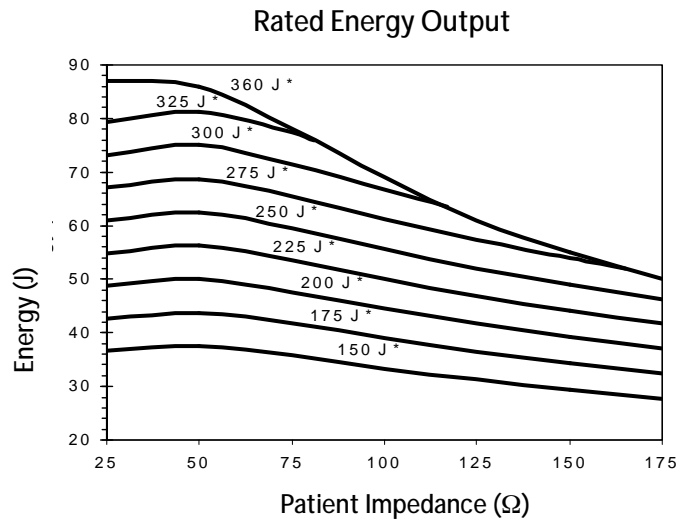

* Energy setting selected

Waveshape and Measured Parameters:

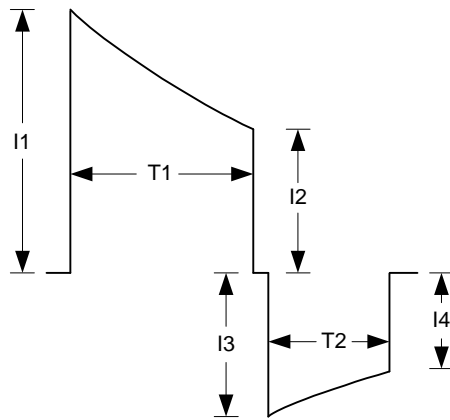

Patient Impedance (Ω)	I1 (A)	I2 (A)	I3 (A)	I4 (A)	T1 (ms)	T2 (ms)
25	19.4	10.2	10.1	6.6	7.6	5.1
50	13.2	7.4	7.3	5.0	8.1	5.4
75	10.1	5.8	5.7	4.0	8.3	5.6
100	8.3	4.8	4.8	3.3	8.6	5.7
125	7.0	4.2	4.1	2.9	8.8	5.9
150	6.2	3.7	3.7	2.6	8.8	5.9
175	5.5	3.3	3.3	2.3	8.9	6.0

Note: Table values are nominal for a 50-joule shock ($200 \div 4$).

Electrical Protection: Input protected against high voltage defibrillator pulses per IEC 60601-1. See [Figure A-1](#).



Figure A-1 Defibrillation-protected, Type BF Patient Connection

Safety Classification: Internally powered equipment. IEC 60601-1

AED Mode

Shock Advisory System (SAS): ECG Analysis system that advises whether a shock is appropriate, meets rhythm recognition criteria specified in DF80 and IEC 60601-2-4. In AED mode, the device allows a shock only if SAS advises defibrillation.

Shock Ready Time: Time to first shock (electrodes connected to a patient at power on and initial rhythm finding is Shock Advised):

- Less than 25 sec to 200 joules
- Less than 30 sec to 360 joules

Energy Sequence: Multiple levels, configurable from 150 to 360 joules

Shock-to-Shock cycle time (200J to 300J): Less than 25 seconds

Time for a 3-shock sequence (200J/300J/360J): Less than 70 seconds

Manual Mode

Energy Sequence: Delivers energy at levels selected in Setup mode.

Charge Time: Charge time:

- 200 joules in less than 7 sec (typical)
- 360 joules in less than 12 sec (typical)

ECG Mode

ECG Display: Provides nondiagnostic ECG display of the patient's heart rhythm.

Display

Size (Active viewing area): 120 mm (4.7 in.) x 89 mm (3.5 in.)

Display Type: 320 dot x 240 dot LCD with backlight

Frequency Response: 0.55 Hz to 21 Hz (-3 dB), nominal

Waveform Sweep Speed: 25 mm/sec for ECG, nominal

Waveform viewing time: Minimum 4 seconds

Waveform Amplitude: 1 cm/mV, nominal
Display Range Differential: ± 1.4 mV full scale, nominal

Specifications

Heart Rate	20 to 300 BPM digital display. Display "---" if heart rate is less than 20 BPM. Heart symbol flashes for each QRS detection
Displayed ECG	ECG information is received from therapy pads in anterior-lateral or anterior-posterior positions, or from the 3-wire ECG cable in Lead II.

Controls

On/Off	Controls device power
Shock	Controls the delivery of defibrillation energy
Soft Keys	Used during device setup and during patient use: Analyze, Charge, Disarm
Menu button	Used to access additional device features

Readiness Display

The readiness display shows device status

OK Indicator	Indicates OK when the last self-test was completed successfully.
Battery Capacity Indicator	Segmented display showing battery capacity
Service Indicator	Service required when displayed

Environmental

Note: All performance specifications defined assume that the device has been stored (two hours minimum) at the operating temperature prior to operation.

Operating Temperature	0° to 50°C (32° to 122°F)
One-Hour Operating Temperature	From room temperature to temperature extreme, one-hour duration: -20° to 60°C (-4° to 140°F)
Storage Temperature	With battery and electrodes, maximum exposure time limited to seven days: -30° to 60°C (-22° to 140°F)
Atmospheric Pressure	575 hPa to 1060 hPa, 4572 to -382 meters (15,000 feet to -1250 feet)
Relative Humidity	5% to 95% (noncondensing)
Dust/Water	IEC 60529 IP55 with battery and REDI-PAK electrodes installed
Shock	MIL-STD-810F, Method 516.5, Procedure 1, (40g peak, 15–23 msec pulse, 45 Hz crossover frequency)
Bump	EN 1789 and IEC 60068-2-29, Test Eb: (1000 bumps, 15g, 6 ms, vertical direction)
Drop	<ul style="list-style-type: none">• 18-inch drop onto each surface, repeated 5 times each, 30 drops total• EN 1789 0.75 meter drop onto each surface, 6 drops total• MIL-STD-810F, 516.5 Procedure IV, 1 meter drop on each corner, edge, and surface
Vibration	MIL-STD-810F, Method 514.5, Category 20 Ground Vehicle: Random vibration test, 1 hour per axis, 3.15g rms
EMC	For EMC information, refer to the EMC tables

Physical Characteristics

Weight	3.2 kg (7.1 lb) with nonrechargeable battery and REDI-PAK electrodes
Height	8.7 cm (3.4 in.)
Width	23.4 cm (9.2 in.)
Depth	27.7 cm (10.9 in.)

Data Storage

Memory Capacity	<ul style="list-style-type: none"> • Dual patient storage • Minimum of 40 minutes of ECG for the current patient • Summarized data stored for the previous patient
Report Types	<ul style="list-style-type: none"> • Continuous ECG—Continuous patient ECG report • Summary—Summary of critical resuscitation events and associated ECG waveforms • Event Log report—Report of time-stamped markers reflecting operator and device activity • Test Log report—Device self-test activity report
Capacity	Minimum 100 time-stamped event log entries
Data Review	CODE-STAT 6.0 (minimum) or DATA TRANSFER Express 2.0 (minimum) software
Communications	Infrared wireless transfer to a personal computer

Primary Battery Pak

Type	Lithium Manganese Dioxide (Li/MnO ₂), 12.0 V, 4.5 amp-hours (nonrechargeable)
Capacity	Typically will provide 440 200-joule discharges or 1030 minutes of operating time with a new battery (370 200-joule shocks or 900 minutes of operating time at 0°C (32°F))
Weight	0.45 kg (1.0 lb)
Shelf Life (prior to installation)	After the battery is stored for 5 years at 20°C to 30°C, the device will provide 48 months of standby life.
Standby Life	A new battery provides device power for 5 years.
Low Battery Indicator	At least 30 200-joule shocks or 75 minutes of operating time remain when low battery is first indicated.

APPENDIX B SHOCK ADVISORY SYSTEM

OVERVIEW OF THE SHOCK ADVISORY SYSTEM

The Shock Advisory System (SAS) is an ECG analysis system built into the LIFEPAK 1000 defibrillator that advises the responder if it detects a shockable or nonshockable rhythm. This system makes it possible for individuals not trained to interpret ECG rhythms to provide potentially-lifesaving therapy to victims of ventricular fibrillation or pulseless ventricular tachycardia. The SAS contains the following features:

- Electrode contact determination
- Automated interpretation of the ECG
- Responder control of shock therapy
- Motion detection

Electrode Contact Determination

The patient's transthoracic impedance is measured through the defibrillation electrodes. If the baseline impedance is higher than a maximum limit, it is determined that the electrodes are not in sufficient contact with the patient or not properly connected to the defibrillator. ECG analysis and shock delivery are inhibited. The responder is advised to connect electrodes any time electrode contact is inadequate.

Automated Interpretation of the ECG

The Shock Advisory System is designed to recommend a shock if it detects the following:

- **Ventricular fibrillation** — with a peak-to-peak amplitude of at least 0.08 mV
- **Ventricular tachycardia** — defined as having a heart rate of at least 120 beats per minute, QRS width of at least 0.16 seconds, and no apparent P waves.

The SAS is designed to recommend no shock for ECG rhythms including pulseless electrical activity, idioventricular rhythms, bradycardia, supraventricular tachycardias, and normal sinus rhythms.

ECG analysis is performed on consecutive 2.7 second segments of ECG. The analysis of two out of three segments must agree before a decision (*SHOCK ADVISED* or *NO SHOCK ADVISED*) is made.

The LIFEPAK 1000 defibrillator SAS performance for adult and pediatric ECGs is summarized in the LIFEPAK 1000 Shock Advisory System (SAS) Performance Report on the LIFEPAK 1000 Product CD.

Control of Shock Therapy

The Shock Advisory System causes the AED to charge automatically when it detects the presence of a shockable rhythm. When a shockable rhythm is detected, the defibrillator instructs the user to deliver the shock by pressing the shock button.

Motion Detection

The Shock Advisory System detects patient motion independent of ECG analysis. A motion detector is designed into the LIFEPAK 1000 defibrillator. Motion Detection can be configured to be ON or OFF.

A number of activities can create motion, including CPR, rescuer movement, patient movement, vehicle movement, and some internal pacemakers. If variations in the transthoracic impedance signal exceed a maximum limit, the Shock Advisory System determines that patient motion of some kind is present. If motion is detected, the ECG analysis is inhibited. The operator is advised by a displayed message, a voice prompt, and an audible alert. After 10 seconds, if motion is still present, the motion alert stops and the analysis always proceeds to completion. This limits the delay in therapy in situations where it may not be possible to stop the motion. However, the rescuer should remove the source of motion whenever possible to minimize the chance of artifact in the ECG.

There are two reasons why ECG analysis is inhibited when the motion alert occurs, and why the rescuer should remove the source of the motion whenever possible:

- Such motion may cause artifact in the ECG signal. This artifact may occasionally cause the Shock Advisory System to reach an incorrect decision.
- The motion may be caused by a responder's interventions. To reduce the risk of inadvertently shocking a responder, the motion alert prompts the responder to move away from the patient. This will stop the motion and ECG analysis will proceed.

APPENDIX C
cprMAX™ TECHNOLOGY

ABOUT cprMAX TECHNOLOGY

Physio-Control cprMAX technology is designed to allow resuscitation protocols to maximize the quantity of CPR administered during treatment with an AED, consistent with the 2005 American Heart Association Guidelines for Cardiopulmonary Resuscitation and Emergency Cardiovascular Care ¹ (AHA Guidelines) and the European Resuscitation Council Guidelines for Resuscitation 2005 ² (ERC Guidelines).

Setup options should be changed only under the direction of a physician knowledgeable in cardiopulmonary resuscitation who is familiar with the literature in this area.

The cprMAX technology includes the following setup options:

- **INITIAL CPR.** Prompts the user to perform an initial period of CPR. Applies only to immediately after turning on the AED or after the first analysis.
- **PRESHOCK CPR Time.** Prompts for CPR after a shockable ECG rhythm is detected, before the shock is delivered. If **INITIAL CPR** is set to **OFF**, then **PRESHOCK CPR** applies to all shock advised decisions (including the first analysis).
- **CPR TIME 1 and 2.** CPR time periods after shocks or no shock advised decisions respectively.
- **STACKED SHOCKS.** Eliminates the analysis after each shock and inserts prompting for CPR after each shock; when set to **OFF**, eliminates the three-stack shock.
- **PULSE CHECK.** Indicates when, if ever, the device is to prompt for pulse checks.

AED protocols are aligned with the AHA and ERC Guidelines when the setup options are set as follows:

- Initial CPR: **OFF**
- PreShock CPR Time: **OFF**
- CPR Times 1 and 2: **120 SECONDS**
- Stacked Shocks: **OFF**
- Pulse Check: **NEVER**

The above options are the factory default settings for cprMAX technology. Your medical director protocols should determine whether or not to change the options and should ensure that you receive training.

AED OPERATION WITH CPRMAX TECHNOLOGY

The following paragraphs describe AED operation with cprMAX technology setup options.

Initial CPR

The **INITIAL CPR** option prompts the user to perform an initial period of CPR. The choices are: **OFF**, **ANALYZE FIRST** and **CPR FIRST**. The factory default is **OFF**.

- The **OFF** setting has no prompting for an initial CPR period.
- The **ANALYZE FIRST** setting prompts for analysis and then CPR. If the analysis determines that a shock is needed, the AED will prompt, *IF YOU WITNESSED THE ARREST, PUSH CANCEL*, which provides the opportunity to end CPR early and proceed directly to delivering a shock.

¹2005 American Heart Association Guidelines for Cardiopulmonary Resuscitation and Emergency Cardiovascular Care. Circulation 2005;112 (Supplement IV).

²European Resuscitation Council Guidelines for Resuscitation 2005. J. Resuscitation 2005; 67 (Supplement 1).

- The CPR FIRST setting prompts the user to perform CPR immediately after the defibrillator is powered on. The AED will also prompt, *IF YOU WITNESSED THE ARREST, PUSH CANCEL*, which provides the opportunity to end CPR early and proceed directly to analysis.

Organizations that choose to implement this option should develop a protocol and provide training to responders instructing them when to end the initial CPR interval early. Potential situations for instructing responders to end CPR early include:

- The patient's collapse was witnessed by the responder.
- The responder ascertains that fewer than four or five minutes have elapsed since the patient's collapse.
- The patient exhibits agonal breathing, an indicator of a short downtime.
- The responder ascertains that CPR of adequate quality and duration has already been provided before attaching the AED electrodes.

Initial CPR Time

The INITIAL CPR TIME option applies when INITIAL CPR is set to ANALYZE FIRST or CPR FIRST. It sets the CPR time for that CPR period. The time choices for INITIAL CPR TIME are: 15, 30, 45, 60, 90, 120, and 180 SECONDS. The default setting is 120 SECONDS.

PreShock CPR Time

The PRESHOCK CPR time option inserts prompting for CPR when a shockable ECG rhythm is detected and during the time the AED is charging. It applies only when analysis results in *SHOCK ADVISED* decisions. When INITIAL CPR is set to OFF or CPR FIRST, PRESHOCK CPR time applies to the first and all subsequent shocks. When INITIAL CPR is set to ANALYZE FIRST, PRESHOCK CPR time applies to the second and all subsequent shocks. The choices for PRESHOCK CPR time are: OFF, 15, and 30 SECONDS. To prompt for CPR only for the time the capacitor is charging, select the 15-seconds CPR interval. The SHOCK button is not enabled until charging and CPR time are completed. The default setting for PRESHOCK CPR time is OFF.

Note: Although the SHOCK button is disabled during the PRESHOCK CPR interval, it becomes active as soon as the PRESHOCK CPR interval ends. To minimize the interval between the final chest compression and shock delivery (while maintaining responder safety), protocols that select this option should provide specific training and protocols to address the rapid transition from PRESHOCK CPR to shock delivery.

Stacked Shocks

When set to OFF, the STACKED SHOCKS option inserts prompting for CPR after each (a single) shock. This eliminates the three-shock stack. CPR is prompted after the shock regardless of the ECG rhythm. The CPR time following the shock is determined by the CPR TIME 1 setting selected. Choices for the STACKED SHOCKS option are ON or OFF. The default setting is OFF.

When this option is set to ON, the defibrillator follows the previously traditional stacked shock protocol and delivers up to three consecutive shocks, as necessary, without interposed CPR.

Pulse Check

The PULSE CHECK option inserts prompting to check for a pulse or check the patient, depending on the PULSE PROMPT setting. The choices for PULSE CHECK are: ALWAYS, AFTER EVERY NSA, AFTER SECOND NSA, and NEVER. The default setting is NEVER.

- The ALWAYS option prompts for a pulse check after CPR TIME 1 and 2, after a *NO SHOCK ADVISED*

decision, after a single *SHOCK ADVISED* decision with STACKED SHOCKS OFF, or after three consecutive *SHOCK ADVISED* decisions if STACKED SHOCKS is ON.

- The AFTER EVERY NSA option prompts for a pulse check after every *NO SHOCK ADVISED* decision.
- The AFTER SECOND NSA option prompts for a pulse check after the second analysis if the second analysis results in a *NO SHOCK ADVISED* decision, regardless of the first analysis decision (*SHOCK ADVISED* or *NO SHOCK ADVISED*).
- The NEVER option eliminates all PULSE CHECK prompts.

APPENDIX D

CHANGING SETUP OPTIONS

CHANGING SETUP OPTIONS

Setup options allow you to define operating features for your defibrillator, such as CPR intervals. Setup options are listed in tables beginning with [Table D-1](#).

To enter Setup mode:

- 1 Ensure that no electrodes or cables are connected to the defibrillator.
- 2 Press and hold both softkeys and press the ON/OFF button. The Enter Setup Mode screen appears.

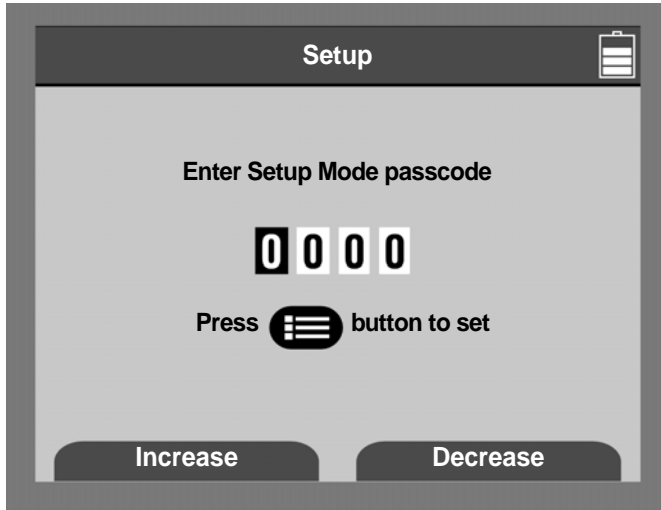

Figure D-1 Enter Setup Mode

- 3 Enter the Setup mode passcode. The factory default passcode is 0000—press the MENU button four times to accept the default passcode. For information on how to change the passcode, see [page D-6](#).

Note: To exit Setup mode, turn the defibrillator off. If you changed the setup options, the changes are saved and will appear the next time you turn the defibrillator on. (Refer to Setup menu options that follow.)

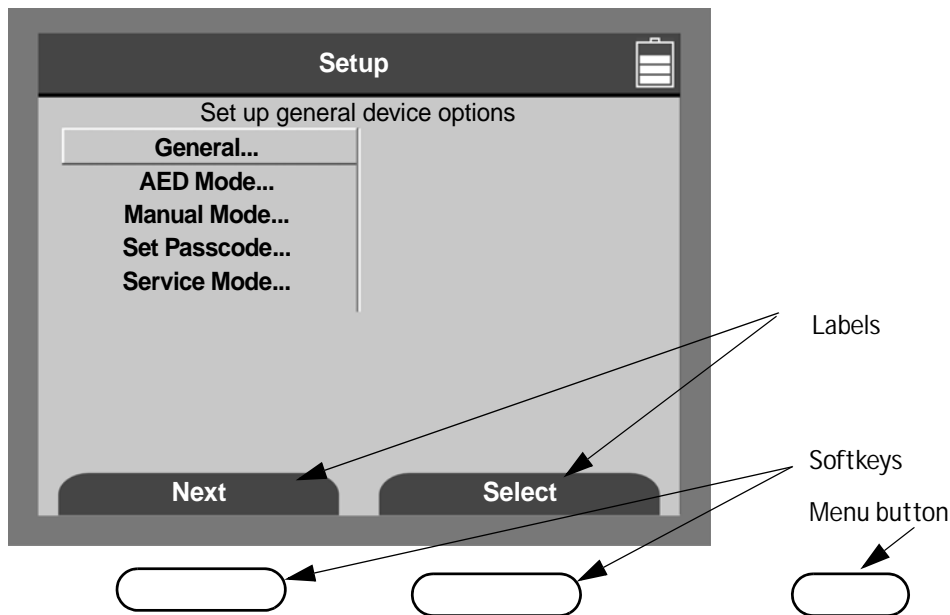

Figure D-2 Setup Mode Screen

Setup Menu Options

All setup options for your defibrillator are grouped under these top-level headings.

- General
- AED Mode
- Manual Mode
- Set Passcode
- Service Mode

Use the softkeys to navigate and make selections on the Setup screen. The label on the screen and above each softkey identifies the current softkey function.

Press NEXT to advance through the menu options.

When an option is highlighted, a Help message about the option appears at the top of the screen, as shown in [Table D-1](#).

Table D-1 Top-Level Setup Menu

Menu Item	Help Message	Options
GENERAL	Set up general device options.	See How to Enter and Delete Device Information, page D-7 .
AED MODE	Set up AED mode defaults.	
MANUAL MODE	Set up Manual mode defaults.	
SET PASSCODE	Set passcode to enter Setup mode.	
SERVICE MODE	View service options.	

To choose an option, highlight your choice on the screen and press SELECT.

Access the General Setup menu from Setup to view general purpose settings. The underlined bold options in [Table D-2](#) are the factory default settings.

Table D-2 General Setup Menu

Menu Item	Help Message	Options
DEVICE ID	Set the device ID.	User selectable, 0-9, A-Z, up to 20 characters. Default is <u>SERIAL NUMBER</u> .
DATE/TIME	Set current date and time.	Default is <u>PACIFIC TIME</u> .
AUDIO	Set audio parameters.	See Table D-3 .
DEVICE DATA	Display device data.	
DELETE AFTER SEND	Delete patient data after sending.	ON, <u>OFF</u> .
PREVIOUS PAGE	Go back to previous page.	

Access the audio options from Audio on the General Setup menu. The underlined bold options in [Table D-3](#) are the factory default settings.

Table D-3 General Setup Menu—Audio Setup Submenu

Menu Item	Help Message	Options
PROMPT VOLUME	Set volume for alarms, tones, and voice prompts.	MEDIUM, <u>HIGH</u> .
SHOCK TONE	Enable shock tone.	ON, <u>OFF</u> .
SERVICE ALERT	Enable the service alert tone.	ON, <u>OFF</u> .
PREVIOUS PAGE	Go back to previous page.	

Access the AED menu from the AED Mode option in Setup. The underlined bold options in [Table D-4](#) are the factory default settings.

Table D-4 AED Setup Menu

Menu Item	Help Message	Options
ENERGY PROTOCOL	Set the defibrillation energy sequence.	See Table D-5 .
CPR	Set CPR options for AED mode.	See Table D-6 .
PULSE	Set pulse prompt options for AED mode.	See Table D-7 .
ECG DISPLAY	Display ECG waveform in AED mode.	<u>ON</u> , OFF.
AUTO ANALYZE	Select analyze option.	<u>ON</u> , AFTER FIRST SHOCK, OFF.
MOTION DETECTION	Alert when motion is detected.	<u>ON</u> , OFF.
PREVIOUS PAGE	Go back to previous page.	

Changing Setup Options

Access Energy Protocols from the AED menu. The underlined bold options in [Table D-5](#) are the factory default settings.

Table D-5 AED Setup Menu—Energy Protocols Submenu

Menu Item	Help Message	Options
ENERGY 1	Select energy level for shock 1.	150, 175, <u>200</u> , 225, 250, 275, 300, 325, 360* joules.
ENERGY 2	Select energy equal to or greater than Energy 1.	150, 175, 200, 225, 250, 275, <u>300</u> , 325, 360 Joules.
ENERGY 3	Select energy equal to or greater than Energy 2.	150, 175, 200, 225, 250, 275, 300, 325, <u>360</u> joules.
FLEXIBLE PROTOCOL	Repeat previous energy after <i>NO SHOCK ADVISED</i> (only when <i>NO SHOCK ADVISED</i> follows a shock).	<u>ON</u> , OFF.
STACKED SHOCKS	Enable consecutive shocks without CPR.	ON, <u>OFF</u> .
PREVIOUS PAGE	Go back to previous page.	

* When selecting 360 joules for energy 1, consider AED use in children.

Access CPR Setup from the AED menu. The underlined bold options in [Table D-6](#) are the factory default settings.

Table D-6 AED Setup Menu—CPR Submenu

Menu Item	Help Message	Options
CPR TIME 1	Set CPR interval after shocks.	15, 30, 45, 60, 90, <u>120</u> , 180 seconds.
CPR TIME 2	Set CPR interval after <i>NO SHOCK ADVISED</i> .	15, 30, 45, 60, 90, <u>120</u> , 180 seconds.
INITIAL CPR	Enable Initial CPR.	<u>OFF</u> , ANALYZE FIRST, CPR FIRST.
INITIAL CPR TIME	Set CPR interval after first analysis.	15, 30, 45, 60, 90, <u>120</u> , 180 seconds.
PRESHOCK CPR	Set CPR interval before <i>SHOCK ADVISED</i> decisions.	<u>OFF</u> , 15, 30 seconds.
CPR PROMPT	Enable extended CPR prompt: <i>PROVIDE RESCUE BREATHS AND CHEST COMPRESSIONS</i>	ON, <u>OFF</u> .
PREVIOUS PAGE	Go back to previous page.	

Access Pulse Setup from the AED menu. The underlined bold options in [Table D-7](#) are the factory default settings.

Table D-7 AED Setup Menu—Pulse Setup Submenu

Menu Item	Help Message	Options
PULSE CHECK	Enable pulse check prompt.	<u>NEVER</u> : Never prompt for <i>PULSE CHECK</i> . AFTER SECOND NSA: After every NSA except for first analysis NSA result. AFTER EVERY NSA: Only after <i>NO SHOCK ADVISED</i> . ALWAYS: After every stack of shocks and every NSA finding.
PULSE PROMPT	Select prompt for patient vital signs.	<u>CHECK PULSE</u> , CHECK BREATHING, CHECK CIRCULATION, OPEN AIRWAY.
AED MONITORING	Enable monitoring while in AED mode.	ON, <u>OFF</u> .
MONITORING REPEAT	Select AED monitoring prompt repeat time.	OFF, <u>1</u> , 2, 3, or 5 minutes.
PREVIOUS PAGE	Go back to previous page.	

Access the Manual menu from the Manual Mode option in Setup. The underlined bold options in [Table D-8](#) are the factory default settings.

Table D-8 Manual Setup Menu

Menu Item	Help Message	Options
MANUAL ACCESS	Enable Manual mode access.	ON, <u>OFF</u> .
ANALYZE	Enable SAS analysis in Manual mode. (An ANALYZE softkey is provided in Manual mode.)	ON, <u>OFF</u> .
PREVIOUS PAGE	Go back to previous page.	

Access the Set Passcode screen, shown in [Figure D-3](#), from the top-level Setup menu.

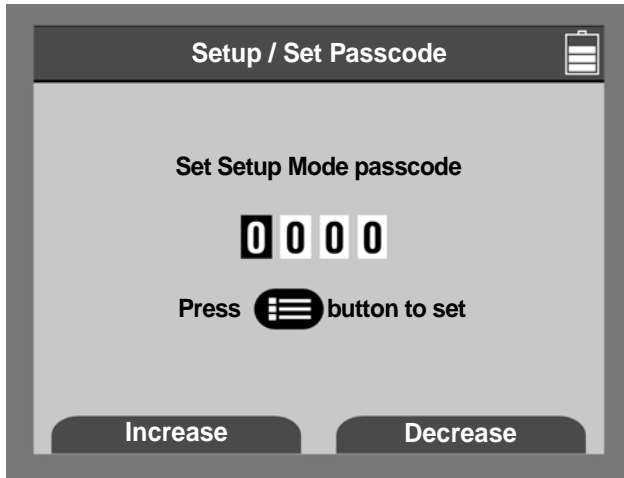

Figure D-3 Set Passcode Screen

Use the INCREASE and DECREASE softkeys and the MENU button to set the passcode. Be sure to record the new passcode—the passcode is required each time you enter Setup mode.

Access Service mode, shown in [Table D-9](#), from the top-level Setup menu.

Table D-9 Service Setup Menu

Menu Item	Help Message	Options
DEFIB CAL	Start defibrillator calibration.	
PIXEL TEST	Test display pixels.	
SERVICE LOG	Show service log.	
SERVICE DATA	Show device data.	
DEVICE LOG	Display device log.	
SET PASSCODE	Set Service mode access passcode.	
SETUP MODE	Go back to Setup mode.	

How to Enter and Delete Device Information

Figure D-4 shows the Device ID screen used to enter device information into the defibrillator.

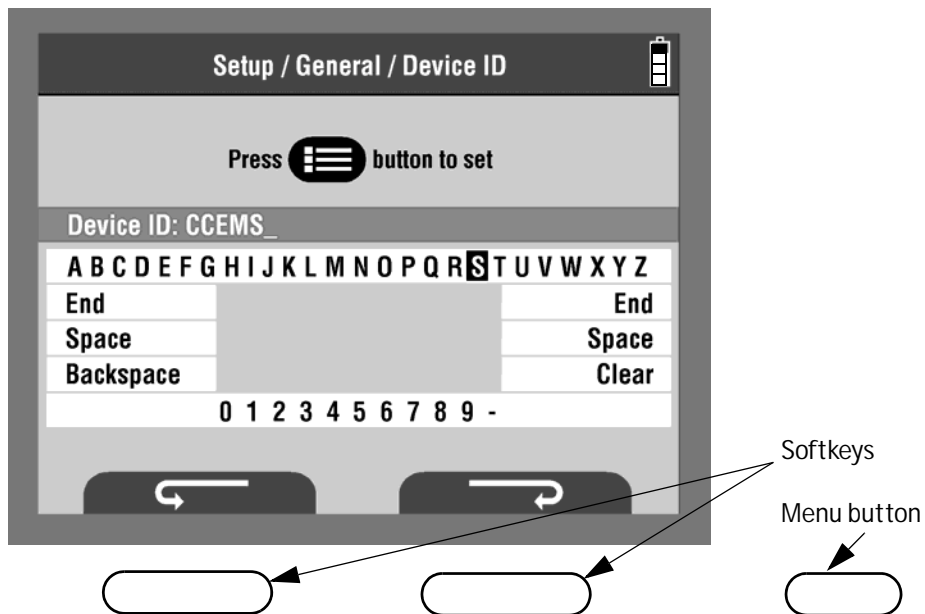

Figure D-4 Device ID Screen

To enter device information:

- 1 Use the softkeys under the clockwise and counterclockwise arrows to navigate to the character or number you want to enter.

Note: Pressing the clockwise arrow moves the cursor forward one space at a time; the counterclockwise arrow moves it back one space at a time.

- 2 Press the MENU button to choose the character. The character appears on the screen above the alphabet area.
- 3 Continue adding characters to complete your entry.
- 4 When your completed entry is composed on the screen, select END.

To delete device information:

- 1 Use the clockwise or counterclockwise arrows to navigate to the BACKSPACE option.
- 2 Navigate to the CLEAR option and press the MENU button again. The character no longer appears on the screen.

APPENDIX E USER'S CHECKLIST

LIFEPAK® 1000 DEFIBRILLATOR

USER'S CHECKLIST



Unit Serial Number _____

Department/Location _____

Instruction	Recommended Corrective Action	Date							
		Initials							
1 Check readiness display for: WRENCH symbol OK symbol Battery level	Contact authorized service personnel. None. Replace if low battery indicated.								
2 Check Use By date on electrode packet.	Replace electrode packet if date has passed.								
3 Check additional supplies.	Replenish as needed.								
4 Check defibrillator for: Damage or cracks Foreign substances	Contact authorized service personnel. Clean the device.								
5 Comments:									

INDEX

A

About
Defibrillation vi, 3-3, 3-5
LIFEPAK 1000 defibrillator vii
Accessories 5-7
AED mode vi, 3-2, 3-3, A-5
AED Mode setup menu D-3
AED operation C-1
Alternate anterior-posterior
electrode position 3-5
Audio setup submenu D-3
Auto Tests 5-2

B

Battery viii, 5-4, 5-6, A-7
Battery maintenance 5-4, 5-5
Battery Status Symbol 2-4

C

Caring for LIFEPAK 1000
defibrillator 5-1
Caution 1-2
Cautions
Cleaning 5-4
General caution 1-3
General therapy 3-2
Nonrechargeable battery 5-5
Checklist, User's E-3

Cleaning 5-4
CODE-STAT software 4-3
Controls and indicators 2-2, A-6
CPR setup submenu D-4
cprMAX Technology viii

D

Danger 1-2
Data management viii, 4-2
Event and Test Log 4-3
Test and service data 4-2
Data storage 4-2, A-7
Data transfer 4-3, 4-4
Defibrillation waveform vii, A-1
Defibrillator
Cleaning 5-4
Inspection 5-3
Recycling 5-6
Defibrillator data 4-2
Deleting of patient data 4-2
Device ID screen D-7
Device information D-7
Disposing nonrechargeable
battery 5-6

E

ECG display (optional) vii, 2-4,
A-5

ECG electrodes, connecting 3-8
ECG monitoring/mode 3-2, 3-8,
A-5
Electrode Contact
Determination B-1
Electrode placement,
defibrillation 3-4, 3-5
Electrodes storage 5-5
Energy Protocols submenu D-4
Entering
Device information D-7
Setup mode D-1
Event and Test Log 4-3

F

Features
Battery viii
cprMAX Technology viii
Daily self-test viii
Data management viii
ECG display (optional) vii
Heart rhythm analysis vii
LIFEPAK 1000 defibrillator vii
Readiness display viii

G

General setup menu D-3

- H**
 - Heart Rate Indicator 2-4
 - Heart rhythm analysis vii, B-1
- I**
 - Implanted pacemakers/
defibrillators 3-4, 3-5
 - Indications for use vi
 - Inspection 5-3
 - IrDA adapter 4-3
 - IrDA connections 4-3, 4-4
 - IrDA port 2-3
- M**
 - Maintenance and testing
schedule 5-2
 - Maintenance, Battery 5-4
 - Manual mode 3-2, 3-5, A-5
 - Manual mode therapy 3-5
 - Manual setup menu D-5
 - Modes of operation 3-2
 - Monitoring in ECG mode 3-8
 - Motion Detected 3-7
 - Motion detection B-1, B-2
- N**
 - No shock advised operating
scenario C-1
- O**
 - Obese patients 3-4
- P**
 - Pacemakers, patients with
implanted 3-4
 - Packaging recycling 5-6
 - Pediatric patients 3-3
 - Physical Characteristics A-7
 - Placing electrode pads 3-3, 3-5,
3-6
 - Product recycling 5-6
 - Pulse setup submenu D-5
- R**
 - Readiness Display viii, 2-2, A-6
 - Recycling 5-6
- S**
 - Self-test viii, 5-2
 - Service 5-6
 - Setup options and menus D-2
 - Shock Advisory System vii, B-1
 - Special situations for electrode
placement 3-4
 - Specifications A-1
- Supplies** 5-7
- Symbols** 1-3
- T**
 - Terms
 - Caution 1-2
 - Danger 1-2
 - Warning 1-2
 - Test and service data 4-2
 - Text conventions viii
 - Therapy in AED mode 3-3
 - Thin patients 3-4
 - Training tools 5-7
 - Transmitting reports 4-3
 - Troubleshooting
 - Defibrillation 3-6
 - During ECG monitoring 3-9
- V**
 - Voice prompts 3-4
- W**
 - Warnings
 - Battery maintenance 5-4, 5-5
 - ECG monitoring 3-8
 - General warnings 1-2
 - Nonrechargeable battery 5-5
 - Pediatric patients
defibrillation 3-3
 - Service and repair 5-6
 - Warranty information 5-7



Physio-Control, Inc.
11811 Willows Road NE
Redmond, WA 98052 USA
Telephone: 425.867.4000
Toll Free (USA only): 800.442.1142
Fax: 425.867.4121
www.physio-control.com



Medtronic B.V.
Earl Bakkenstraat 10
6422 PJ Heerlen
The Netherlands

